

**Kotao na  
BIOMASU/**

***Heating boiler  
BIOMASS  
OPERATED***

**SERIJE  
Ecoflame  
Plus/  
SERIES  
Ecoflame Plus**



## **INSTRUKCIJE/ INSTRUCTION MANUAL**

*Montaža, korišćenje i održavanje kotla/ Assembly, use and maintenance of heating boiler*

## Sadržaj

1. Važna upozorenja.....	4
1.1. Minimalna udaljenost od zapaljivih materijala .....	5
2. Opis kotla .....	6
2.1. Presek kotla Ecoflame Plus sa opisom elemenata.....	7
2.2. Konstrukcija .....	8
3. Montaža.....	11
3.1 Opšta upozorenja.....	11
3.2 Mere i uređaji bezbednosti kod kotla Ecoflame Plus.....	12
3.3 Pozicioniranje kotla Ecoflame Plus u kotlarnici. ....	15
3.4. Priklučenje na dimnjak.....	16
4. Šema vezivanja automatike.....	20
5. Tabela sa tehničkim podacima.....	21
6. Hidraulička šema .....	23
7. Start rada kotla i održavanje .....	24
7.1. LCD 100 displejom .....	24
7.2. Funkcionalna stanja sistema.....	31
7.3. Senzor za detektovanje otvorenih vrata kotla .....	31
7.4. Termostat za nadzor temperature peleta.....	32
7.5. Instaliranje dodatne opreme .....	32
7.5.1. Uvodne napomene .....	32
7.5.2. Sobni termostat ili senzor spoljnje temperature .....	32
7.5.3. Start rezervnog/dodatnog izvora toplote.....	34
7.5.4. Dodatni sistem za doziranje peleta .....	34
7.6. Menadžment distribucije vode .....	34
7.6.1. Uvodne napomene .....	34
7.6.2 Konfiguracija 10.0 .....	35
7.6.3 Konfiguracija 10.1 .....	36
7.6.4 Konfiguracija 10.2 .....	37
7.6.5. Konfiguracija 10.3 .....	39
7.6.6. Spisak temperaturnih parametara/termostata.....	40
7.7. Zaštita od blokade pumpe i trokrakog ventila.....	41

7.8. Resetovanje na fabrička podešavanja.....	41
7.9. Puštanje u rad kotla .....	41
7.10. Održavanje kotla Ecoflame Plus .....	42
10. Nalepnica .....	46
11. Proizvođač.....	51
12. Garancija.....	52

—

## 1. Važna upozorenja

### OPŠTA UPOZORENJA

- Nakon uklonjenog pakovanja uveriti se u kompletnost isporuke, i u slučaju nedostataka, obratiti se prodavcu koji je prodao kotao.
- Kotao mora biti upotrebljen isključivo za namenu koju je predvideo proizvođač. Isključuje se bilo kakva odgovornost od strane proizvođača za štetu uzrokovanu osobama, životinjama ili stvarima, u slučaju grešaka pri montaži, regulaciji, održavanju ili nepravilnom korišćenju.
- U slučaju curenje vode isključiti uređaj sa električnog napajanja, zatvoriti napajanje vodom i obavestiti ovlašćeni servis ili ovlašćenog montera.
- Ovo uputstvo je sastavni deo uređaja i mora se čuvati sa pažnjom i mora **UVEK** pratiti uređaj i u slučaju promene vlasnika ili korisnika ili u slučaju priključenja na drugu instalaciju. U slučaju oštećenja ili nestanka tražiti novi primerak od ovlašćenog prodavca.



### VAŽNA UPOZORENJA

Podsećamo da korišćenje uređaja na biomasu i čvrsto gorivo i koji imaju kontakt sa električnom energijom i vodom zahtevaju poštovanje sigurnosnih mera i to:

- Zabranjeno je korišćenje kotla od strane dece i osoba sa ograničenim mogućnostima bez pratnje.
- Zabranjeno je korišćenje kotla na instalacijama sa radnom temperaturom većom od 110°C, i radnim pritiskom većim od 3 bar-a.
- Zabranjeno je korišćenje lako zapaljivih goriva (alkohol, nafta).
- Zabranjeno je odlaganje lako zapaljivih materijala u blizini kotla i u blizini vrata za loženje. Pepeo se mora odlagati u zatvorene i nezapaljive spremnike.
- Zabranjeno je spaljivanje otpada i materijala čije sagorevanje prouzrokuje plamen ili opasnost od eksplozije (npr. plastične kese, piljevinu, ugljenu prašinu, blato itd.)
- Zabranjena je bilo kakva intervencija tehničkog lica (naročito se to odnosi na zamenu grejača ili proveru ispravnosti nekog drugog el. uređaja...) ili čišćenja, pre nego se kotao isključi sa električnog napajanja i to izvlačenjem utičnice iz glavnog mrežnog napajanja.
- Zabranjena je izmena na sigurnosnim elementima.
- Zabranjeno je zatvaranje ventilacionih otvora na prostoriji u kojoj se nalazi kotao. Ventilacioni otvori su neophodni za pravilno sagorevanje
- Zabranjeno je izlaganje kotla atmosferskim neprilikama. Sam kotao nije predviđen za spoljnu montažu i ne sadrži sistem protiv smrzavanja.
- Zabranjeno je isključivanje kotla ukoliko spoljna temperatura može da padne ispod NULE (opasnost od smrzavanja).
- U slučaju intervencije na bilo kom elektro uređaju kotla, ceo uređaj isključiti sa elektro instalacije i to tako što se izvadi utičnica iz mrežnog napajanja.
- Rad sa uređajem kotla zabranjen je ljudima sa posebnim potrebama (uključujući i decu) kako fizičkim tako i mentalnim, osim uz nadzor staratelja i ljudi koji su odgovorni za njihova ponašanja.
- Deca moraju biti pod nadzorom staratelja kako se ne bi igrala sa uređajem kotla.
- Ako je oštećena strujna zaštita, mora biti zamenjena u samoj fabrici i servisirana od strane ovlašćenog servisera ili kvalifikovanih ljudi da bi se izbegao rizik od strujnog udara.

## 1.1. Minimalna udaljenost od zapaljivih materijala

- Obezbedite odgovarajuću udaljenost od zapaljivih materijala, ako je potrebno obezbediti zaštitu istih.
- Minimalna udaljenost od zapaljivih materijala je propisana zakonom- molimo da se o tome raspitate kod stručnih lica, koja se bave grejanjem, i dimničara.
- Minimalna udaljenost kotla i cevi za odvod dimnih gasova od slabo i prosečno gorivih materijala treba da bude najmanje 100mm.
- Minimalno rastojanje od lako zapaljivih materijala je 200mm, a isto važi i za materijale čija zapaljivost nije poznata.



### Opasnost od požara!

- Skladištenje zapaljivih materijala i tečnosti u blizini kotla je zabranjeno.
- Obavezno upozorite korisnike o potrebnoj minimalnoj udaljenosti zapaljivih materijala od kotla.

<b>Zapaljivost građevinskih materijala</b>	
<b>A... nezapaljivi</b>	azbet, kamen, građevinski kamen, keramičke zidne pločice, terakota, malter, cementna glazura (bez organskih dodataka);
<b>B... koji nisu lako zapaljivi</b>	gipsane kartonske ploče, staklena vlakna, ploče od AKUMINA, IZOMINA, RAJOLITA, LIGNOSA, VELOKSA I HERAKLITA;
<b>C1... slabo gorivi</b>	bukovo i hrastovo drvo, kompozitno drvo, filc, ploče od HOBREKSA, VERZALITA, UMAKARTA;
<b>C2... prosečno gorivi</b>	drvo bora, tise i jele, kompozitni materijali;
<b>C3... lako zapaljivi</b>	asfalt, karton, celulozni materijali, iverica, pluta, poliuretan, polistiren, polipropilen, polietilen, podna vlakna.

## 2. Opis kotla

- Kotao *Ecoflame Plus 25/30* je razvijen sa ciljem da RADIJATOR INŽENJERING ponudi tržištu kotao koji je po svojim mehaničkim i termičkim osobinama izrazito namenjen peletu kao gorivu.
- **Ukoliko korisnik želi da koristi neki oblik biomase koji nije naveden, obavezno treba da kontaktira službu konstrukcije i razvoja Radijator inženjeringa ili ovlašćenog prodavca, jer vrlo često pojedini oblici biomase zahtevaju posebna, specifična rešenja sagorevanja.** Prilikom korišćenja navedenih goriva podrazumeva se automatska kontrola glavnih parametara rada. U svim navedenim primerima korišćenja biomase zahteva se određen stepen suvoće goriva. Sa druge strane zahtevi tržišta su uvek okrenuti ka što većoj univerzalnosti goriva.
- Drveni peleti su dobijeni od 100% celuloze. Ostaci drveta pod visokim pritiskom su sabijeni u pelet prečnika 6mm i dužine 2-3 cm. Pelet treba pravilno skladištiti i to na suvom mestu da bi se obezbedilo efikasno sagorevanje. Kotao *Ecoflame Plus 25/30* koristi pelet prečnika 6 mm, dužine 5-30 mm i vlažnosti do 10% izrađen po standardu **EN 14962-2**. Ukoliko pelet nije po navedenom standardu ili je tokom skladištenja ili transporta došlo do pogoršanja njegovog kvaliteta, Radijator Inženjering kao proizvođač ne može da preuzme odgovornost za loš rad. U takvim situacijama dolazi do grešaka u paljenju, nagomilavanja peleta i ispadanja iz prostora za sagorevanje, nedovoljne snage itd.
- *Ecoflame Plus* se instalira u kotlarnici ili u drugim prostorijama, s tim što ima prednost u situacijama gde su potrebne što kompaktnije dimenzije.
- Montira se na klasični dimnjak minimalnog prečnika 130mm. Dimnjak mora da zadovoljava i sve ostale standarde kao kod klasičnih kotlova o čemu je više rečeno u poglavlju montaža.
- U okviru kotla instalirani su i odgovarajuća cirkulaciona pumpa. Kotao se isporučuje sa sigurnosnim i odzračnim ventilom. Pored modela *Ecoflame Plus* postoji i model *Ecoflame* koji ne poseduje cirkulacionu pumpu, sigurnosni ventil, pp slavinu.
- Sagorevanje peleta se vrši po principu izvirućeg ložišta.
- Ceo proces je vođen automatikom koja dozvoljava odabir jedan od dva nivoa snage (25/30kW).
- Moguće je priključiti sobni termostat i isprogramirati periode starta rada i cikluse mirovanja za 7 dana.

## 2.1. Presek kotla Ecoflame Plus sa opisom elemenata

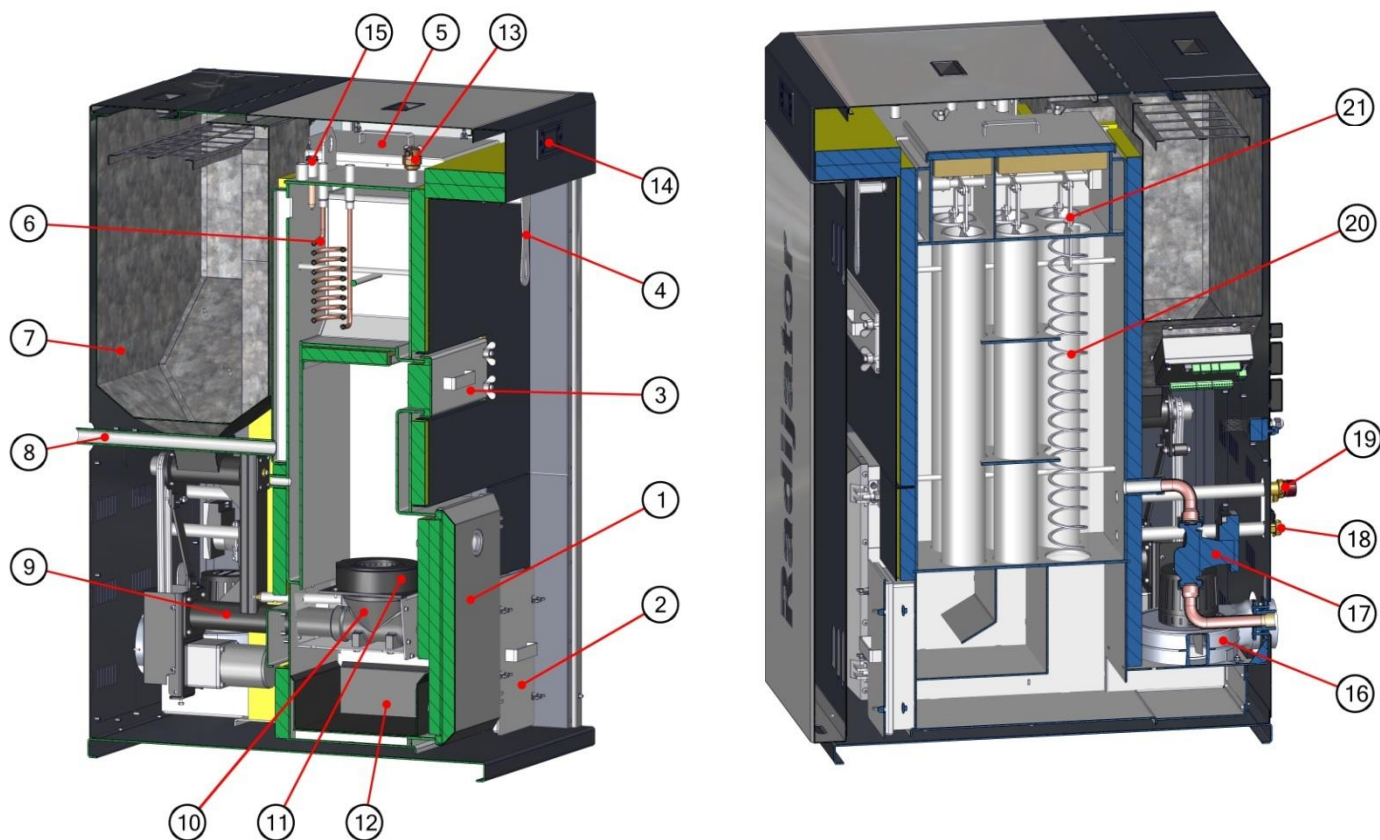

Slika 1. Presek kotla Ecoflame Plus

Redni broj	Naziv pozicije
1	Vrata kotla;
2	Donji poklopac revizionog otvora za čišćenje izmenjivača;
3	Gornji poklopac revizionog otvora za čišćenje iznad ložišta;
4	Ručica mehanizma za čišćenje izmenjivačkih cevi;
5	Gornji poklopac revizionog otvora za čišćenje izmenjivača;
6	Termičko osiguranje;
7	Silos;
8	Potisni vod;
9	Dozer;
10	Kanal gorionika - T komad;

11	Prohromska šolja;
12	Pepeljara;
13	Odzračni ventil;
14	Displej automatike;
15	Sonda za temperaturu;
16	Ventilator, Ø100;
17	Elektronska pumpa;
18	Slavina za punjenje i pražnjenje;
19	Ventil sigurnosti;
20	Turbulator za čišćenje cevi izmenjivača;
21	Mehanizam za čišćenje izmenjivača

## 2.2. Konstrukcija

Po načinu sagorevanja, kotao *Ecoflame Plus 25/30* pripada grupi kotlova gde masa koja sagoreva izvire u komoru za sagorevanje.

Vodeni deo kotla, njegov način izmene toplote između dimnih gasova i vode, prilagođen je biomasi. Svi delovi vodenog dela kotla izrađeni su od bešavnih cevi kvaliteta **ST 35.4** i kotlovskih limova debljine 5 mm. Limovi su kvaliteta **1.0425 EU** standard odnosno **P265GH** standard **EUII**.

Izmenjivač je tropromajni izgrađen od vertikalno postavljenih cevi. Zahvaljujući tropromajnom sistemu cirkulacije dimnih gasova kotao ima visoku efikasnost, a ovakve karakteristike rezultiraju uštedom energije i manjim zagađenjem životne sredine.

Unutar cevi izmenjivača postavljeni su spiralni turbulatori koji imaju dvostruku funkciju. Prva je da povećaju izmenu dimnih gasova i izmenjivača i samim tim i efikasnost kotla, a druga mehaničko čišćenje zidova cevi. Na *slici 2* prikazani su turbulatori, koji se pokretanjem ručice levo-desno, pomeraju gore-dole i tako čiste cevi izmenjivača, veoma je bitno da se ovaj proces čišćenja obavlja svakodnevno.

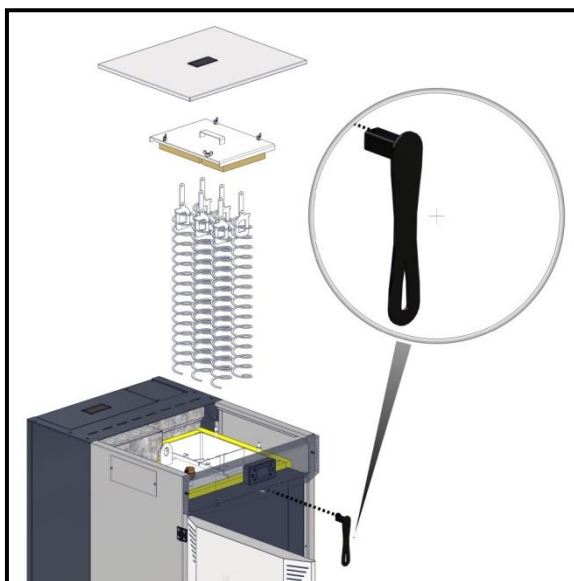

*Slika 2. Prikaz turbulatora*

Stepen korisnosti na pelet je preko 91 %. Vrednosti temperature dimnih gasova mogu u svakom trenutku da se očitaju na displeju. Tokom rada dolazi do stvaranja naslaga gareži i pepela na izmenjivačkom delu kotla i to značajno utiče na slabiju izmenu i porast temperature dimnih gasova. Ako se kotao ne čisti duže vreme moguć je toliki porast temperature dimnih gasova da dolazi do ulaska u modulacijski režim rada.

-Ložište je po principu rada tzv. „izviruće“, gde gorivo tj. pelet iz silosa nadolazi u dozer koji ga transportuje preko dve horizontalne spirale u zonu ložišta tj. u kanal gorionika, gde se pelet nagomilava, kanal se puni i izvire u šolju u kojoj sagoreva. Šolja je napravljena od vatrootpornog materijala, *slika 3*.



Izviruće ložište

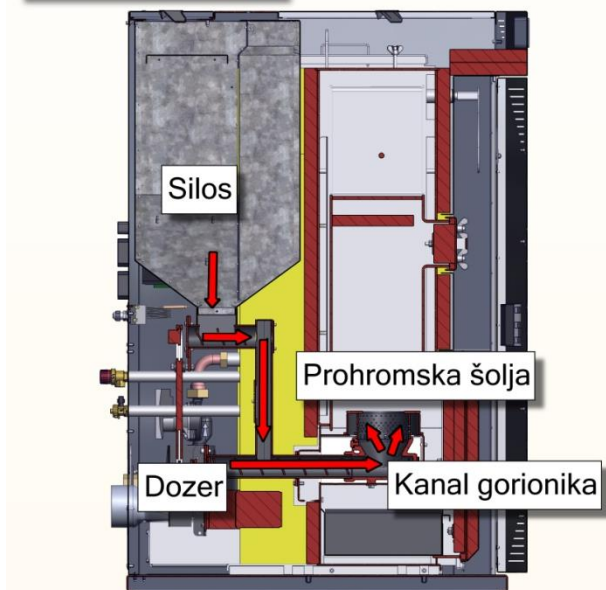

Slika 3. Izviruće ložište

Sagorevanje peleta u prohromskoj šolji prikazano je na *slici 4*. Otvori iznad crvene linije su za sekundarni vazduh, otvori ispod crvene linije su za primarni vazduh. Crvena liniija označava nivo peleta koji sagoreva.

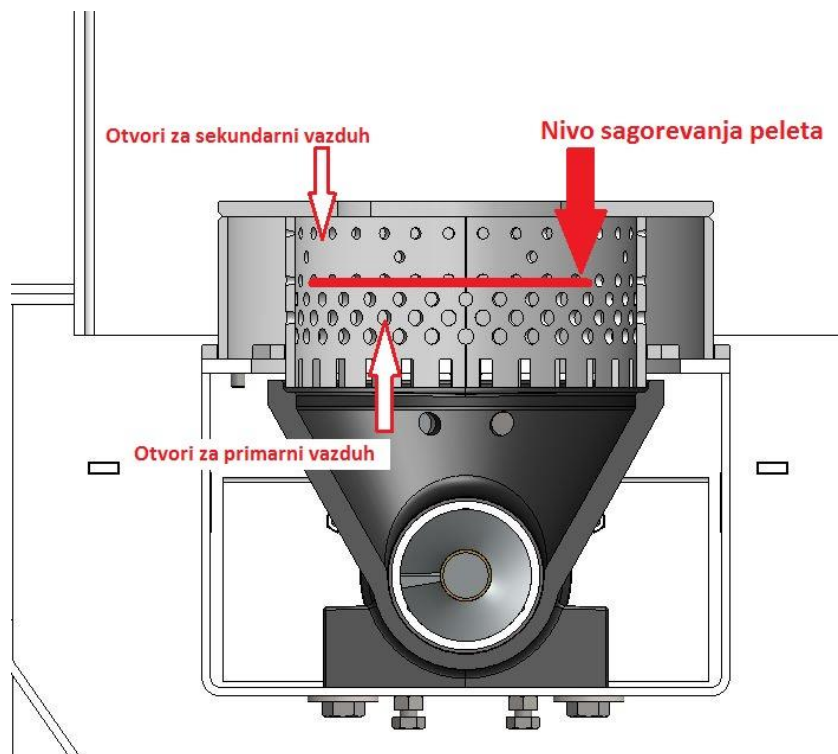

Slika 4. Prikaz sagorevanja peleta u šolji

Ručica koja pokreće mehanizam za čišćenje turbulatora koristi se i za otvaranje vrata ložišta, *slika 5*.

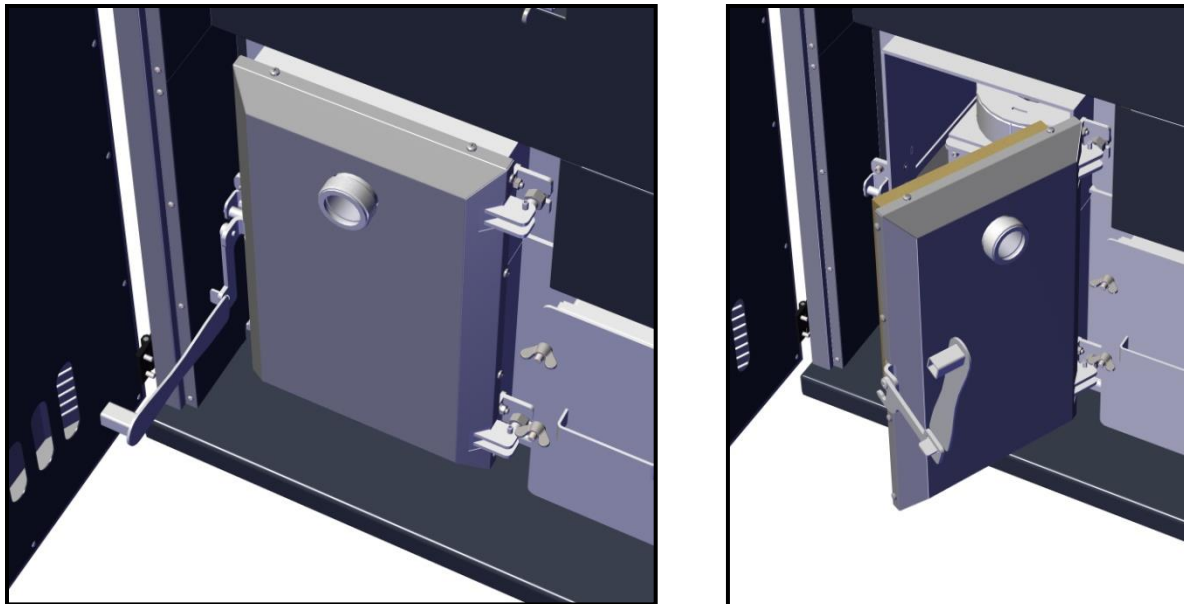

*Slika 5. Otvaranje vrata ložišta*

-Zapremina silosa je 65kg. Mogućnost proširenja kapaciteta dodatnim silosom za pelet, *slika 6*.



*Slika 6. Mogućnost dodatnog silosa, kapacitet 320kg*

## 3. Montaža

### 3.1 Opšta upozorenja

**Kotao mora biti pravilno postavljen zbog pravilnog rada!**



Maksimalni radni pritisak kotla je 3 bar-a, minimalni 1 bar, a maksimalna radna temperatura kotla je 110°C.



Kotao je sa ventilatorom, automatikom, elektro grejačem i svi ovi uređaji koriste napajanje 230V, tako da nepravilno instaliranje i neoprezno rukovanje mogu da ugroze ljudski život strujnim udarom.



Kotao na čvrsto gorivo i prinudnom promajom treba instalirati prema važećim normama i zakonskim propisima. Svaka izmena ili na mehaničkoj konstrukciji ili na električnoj instalaciji smatraće se narušavanjem garancijiskih uslova i dovešće do njenog narušavanja.



Prilikom montaže na hidrauličku instalaciju kotao mora biti obezbeđen na propisan način od prekoračenja maksimalne radne temperature i pritiska.



Za propisnu montažu odgovoran je instalater centralnog grejanja koji priključuje kotao na hidraulički sistem.



Radijator Inženjering, kao proizvođač kotla, ne preuzima nikakvu odgovornost za štete prouzrokovane lošim instaliranjem kotla.



Prilikom bilo kakve intervencije na elektro uređajima kotla Ecoflame, ceo sistem isključiti sa glavnog mrežnog napajanja.

## 3.2 Mere i uređjaji bezbednosti kod kotla Ecoflame Plus

Kotao je opremljen sofisticiranim sigurnosnim uređajima koji u slučaju nepredviđenih situacija zaustavljaju rad kotla, sprečavajući time sve posledice koje mogu biti uzrokovane nepravilnim radom kotla. U svakom slučaju kada se problem pojavi uređaji će zaustaviti ubacivanje peleta i počće faza gašenja kotla.

- **Ventil sigurnosti na pritisak;**
- **Odzračni ventili;**
- **Termostati u automatici koja reguliše rad kotla;**
- **Ventil termičkog osiguranja oticanjem (VTO) (kotao na vrhu ima predviđen priključak za VTO, koji ugrađuje investitor kotla)**

### Ventil sigurnosti na pritisak, prikazan na slici 7 levo

- Ventil sigurnosti na pritisak mora biti nazivnog prečnika 1/2" baždaren na maksimalno 3 bar-a. Ovaj sigurnosni element koji spada u grupu limitatora pritiska mora da bude takve konstrukcije da izdrži i kratkotrajna prekoračenja i temperature i pritiska kao i određen sadržaj glikola u tečnosti za grejanje.
- Ventil sigurnosti nalazi se na zadnjoj strani kotla, izvan oplata iz razloga da ukoliko dodje do aktiviranja, voda koju on ispusti ne ugrozi rad kotla.
- Ventil sigurnosti mora biti montiran na kotlu bez bilo kakvog cevovoda ili bilo kojih drugih elemenata između. Za ovu svrhu postoji i posebno predviđen priključak. Strogo je zabranjeno bilo kakvo reduciranje prečnika ovog priključka.
- Ispusni tj. izduvni deo ventila sigurnosti mora da bude od cevi čiji je prečnik najmanje jednak nazivnom prečniku ispusnog dela ventila. Takođe dozvoljeno je za njegovu izradu koristiti najviše jedan luk radijusa  $r > 3d$ .
- Sigurnosni ventil mora posedovati nazivnu pločicu i na njoj sledeće podatke:
  - naziv proizvođača;
  - oznaka tipa sigurnosnog ventila/godina ispitivanja;
  - nazivni protok;
  - podatak za koji toplotni učinak je sigurnosni ventil podešen;
  - najviši pritisak otvaranja tj. 3 bar-a.
- Obavezna je provera ispravnosti rada u određenim vremenskim periodima kao i ponovna baždarenja od strane sertifikovanih firmi. Ove obaveze se sprovode u skladu sa zakonom svake zemlje u kojoj je kotao namontiran. Obavezno čuvati pisani dokument o podacima zadnjeg baždarenja sigurnosnog ventila.
- Na povratnom vodu montirati barem još jedan ventil sigurnosti na pritisak.

### Odzračni ventil, prikazan na slici 7 desno

- Odzračni ventil je montiran na najvišoj tački kotla. Ovo je još jedna mera sigurnosti koja se odnosi na pojavu vazduha u sistemu i u samom kotlu. Takodje i apsorbuje i nagle trenutne promene pritiska. Maksimalni pritisak koji može da izdrži je 10 bar-a. Ovaj sigurnosni element mora da podleže i periodičnim ponovnim baždarenjima o čemu investitor tj. korisnik kotla mora da poseduje validnu dokumentaciju.

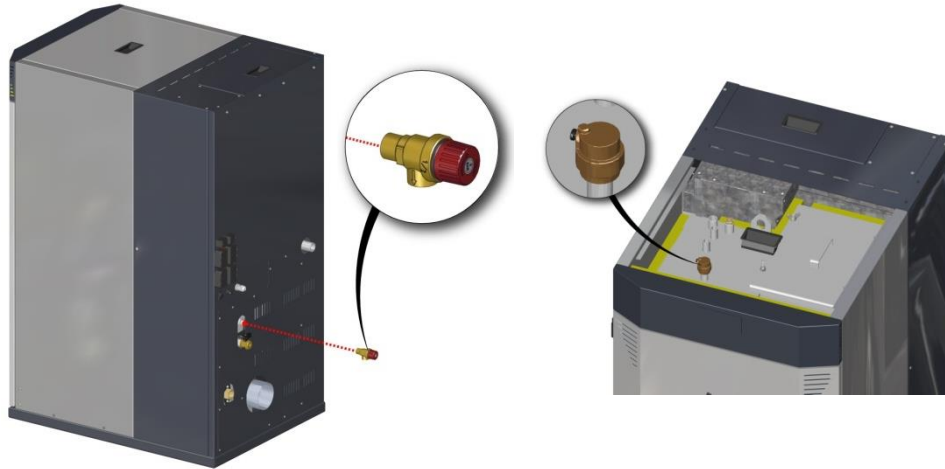

*Slika 7. Prikaz postavljanja sigurnosnih elemenata*

### Termostati u automatici kotla

- Automatici koja vodi proces sagorevanja i utiče na rad kotla i krugova grejanja ima jedan sigurnosni termostat. Sigurnosni termostat ima funkciju kao limitator temperature vode u kotlu, ograničen je na 110°C, *slika 8*. U slučaju pregrevanja, sačekati da temperatura vode padne ispod 60°C i ručno resetovati dugme STB termostata.

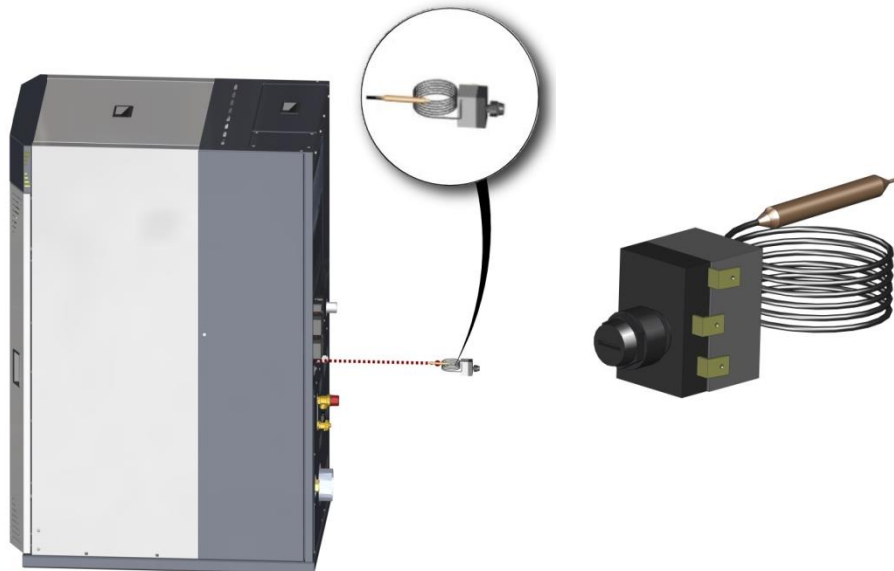

*Slika 8. Sigurnosni termostat na automatici*

- Za automatiku kotla i krugove grejanja koriste se NTC senzori i služe za podešavanje željene temperature. Kotlovska NTC sonda je ograničena na 95°C.
- U slučaju reagovanja bilo kojih sigurnosnih elemenata automatika preuzima niz aktivnosti, ulazi u safety režim rada u kojem je obavezno pumpa uključena da bi se temperatura spustila.

- Pored gore navedenih termostata automatika kotla je opremljena i nalegajućim termostatom za nadzor temperature peleta u silosu, *slika 9*. U slučaju aktivacije ovog termostata automatika preuzima sledeće korake: isključuje dozer i uključuje ventilator, kako bi se zaustavio plamen.



*Slika 9. Nalegajući termostat*

### Ventil termičkog osiguranja oticanjem (VTO)



*Slika 10. Ventil termičkog osiguranja oticanjem*

- Ovaj sigurnosni element ima takođe ulogu ograničivača temperature. U nekim ekstremno opasnim situacijama prelaz vode u vodenu paru je takav da ventili sigurnosti za pritisak nisu dovoljni da obezbede sigurnost hidrauličkog sistema. Iz ovog razloga je obavezna ugradnja VTO. U zavisnosti od zakonskih regulativa zemalja u kojima se kotao montira, VTO je potrebno ugraditi samo za snage veće od određenih ili za svaku snagu kotla obavezno ugraditi VTO. Mesto ugradnje prikazano je na šemi montaže kotla na instalaciju i na *slici 10*. U kotlu se isporučuje bakarna spirala tako da je potrebno koristiti VTO sa izmenjivačem kao na *slici 10*. Do VTO-a se dovodi hladna sanitarna voda. Kada sonda VTO-a ima informaciju da je temperatura preko 95°C VTO se otvara i voda prolazi kroz bakarnu spiralu. Posle izvesnog vremena temperatura vode u kotlu se vraća na normalnu. Jedan priključak spirale koristimo za VTO, a drugi za ispusni je nebitno. Obavezno je pridržavati se uputstava ugradnje koje je dao proizvođač VTO. Obavezno u određenim vremenskim periodima proveravati funkciju VTO. Kao što je već rečeno jedan kraj VTO je za montažu na izmenjivač kotla, a do drugog se dovodi hladna voda pod pritiskom. Naročito je bitno da protok te vode bude neometan i pri nestanku električne energije.



**Ukoliko je nemoguće obezbediti dotok hladne sanitarne vode i pri nestanku el.energije, obavezno kotao priključiti na otvoren sistem.**

Radijator Inženjering d.o.o, 36000 Kraljevo, Živojina Lazića - Solunca br.6, Srbija  
tel. +381 36 399 140, fax. +381 36 399 150, <http://www.radijator.rs>  
e-mail: [radijator@radijator.rs](mailto:radijator@radijator.rs)

### 3.3 Pozicioniranje kotla Ecoflame Plus u kotlarnici.

Kotlarnica mora biti obezbeđena od smrzavanja.

Podloga za kotao u kotlarnici mora biti od nezapaljivog materijala. Preporučene vrednosti udaljenosti sve četiri strane kotla u odnosu na zidove kotlarnice ili neka druga kruta tela (akumulacioni bojler, itd.) prikazane su na *slici 11*. Ove vrednosti udaljenosti omogućavaju siguran pristup prilikom loženja, dovoljan prostor za čišćenje i nesmetan pristup ventilatoru i ventilu za punjenje i pražnjenje. Kotao sa svoje leve strane treba da bude udaljen od zida 400mm. Prostor iza kotla bitan je zbog montaže na hidraulički sistem ali i zbog eventualne demontaže sistema za elektro potpalu. **Kotlarnica mora da poseduje dovoljne otvore za ventilaciju kako za svež vazduh tako i za odvođenje istrošenog vazduha.**

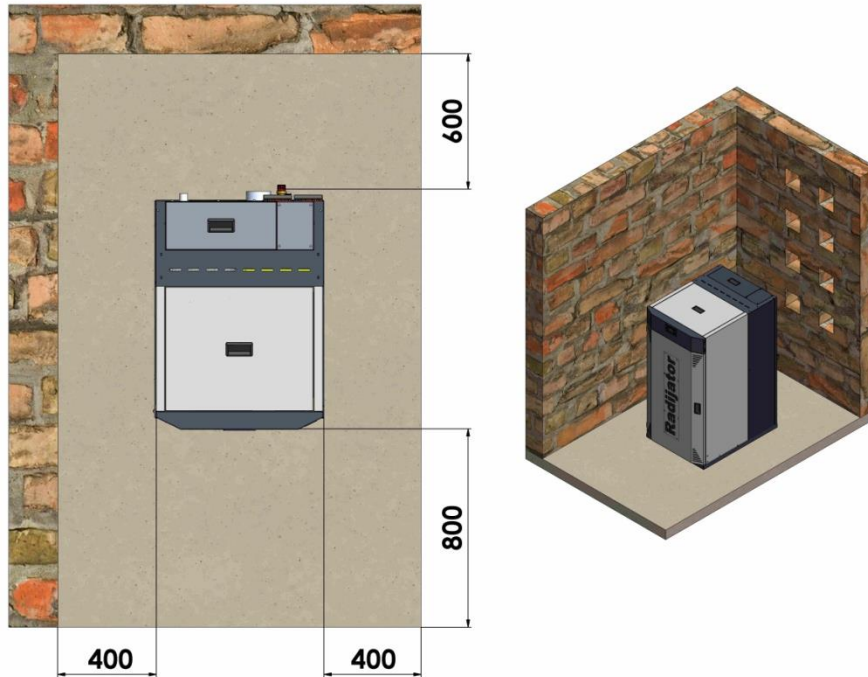

Slika 11. Pozicioniranje kotla u kotlarnici

Ukupna površina ovih otvora je minimalno 150cm<sup>2</sup> za snage do 50kW, a za snagu preko 50kW površina mora biti veća za još 2cm<sup>2</sup> po kW.

$$A = 150 \text{ cm}^2 + \frac{2 \text{ cm}^2}{\text{kW}} \cdot (\sum Q_n - 50 \text{ kW}) \quad \sum Q_n = \text{moguće snage preko 50kW.}$$

Nedostatak dovoljne ventilacije u kotlarnici može da uzrokuje više problema u radu kotla. Glavni problem je nemogućnost postizanja visoke temperature izlazne vode tj. ne postizanje maksimalne snage što dovodi do kondenzovanja u kotlu.

- Uzeti u obzir neophodan minimalni prostor koji je potreban za prilaz sigurnosnim elementima i za izvršenje operacija čišćenja i redovnog remonta.
- Utvrditi da li je stepen električne zaštite u skladu sa karakteristikama prostorije u kojoj će kotao biti smešten.
- Zabranjeno je izlaganje kotla atmosferskim nepravilnostima. Sam kotao nije predviđen za spoljnu montažu i ne sadrži sistem protiv smrzavanja.

Radijator Inženjering d.o.o, 36000 Kraljevo, Živojina Lazića - Solunca br.6, Srbija  
tel. +381 36 399 140, fax. +381 36 399 150, <http://www.radijator.rs>  
e-mail: [radijator@radijator.rs](mailto:radijator@radijator.rs)

- Zabranjeno je zatvaranje ventilacionih otvora na prostori u kojoj se nalazi kotao. Ventilacioni otvori su neophodni za pravilno sagorevanje.

### 3.4. Priklučenje na dimnjak

Prilikom montaže dimnjaka razlikujemo dve situacije:

- **Situacija 1:** Kotao se priključuje na standardni dimnjak (zidani ili metalni) koji ima svoj temelj i pun presek od temeljne ploče do vrha.
- **Situacija 2:** Kotao se priključuje na montažni metalni dimnjak pričvršćen na fasadu.

#### Situacija 1:

- Kao dimnjak koristiti keramičke ili metalne cevi kružnog poprečnog preseka minimalnog prečnika 130mm. Dimna cev obavezno mora biti izolovana.
- Ukoliko dimnjak već postoji i kvadratnog je poprečnog preseka, onda su minimalne dimenzije tog preseka 130x130mm.
- Nije dozvoljeno koristiti dimnjak za priključenje više uređaja.
- Nije dozvoljeno koristiti ventilacione otvore kao dimnjak.
- Vrh dimnjaka zaštititi dimnjačkom kapom zbog uticaja kiše i vetrova. Rastojanje od kape do dimnjaka 200mm.
- Dimnjak treba da izađe u odnosu na krov prema preporukama, *slika 12*. Ukoliko su blizu dimnjaka neki viši objekti uzeti i ovo u obzir i dodatno povećati visinu.
- Dimnjak mora da ima i priključak za izdvajanje kondenza, kao i reviziona vrata. Vrata treba uvek tokom rada dobro da dihtuju.

#### Situacija 2:

- U ovoj situaciji dimovodna cev mora da ide minimalno 1,5m vertikalno uvis u samoj prostori u kojoj je kotao, a zatim da prodre kroz zid i da se priključi na dimnjak.
- Dimovodna cev mora da ima T kondenzacioni komad na samom izlasku iz kotla kao i mogućnost demontaže zbog čišćenja.

**UPOZORENJE: Nepridržavanje pravila tokom izvođenja dimovodnih kanala i dimnjaka može da dovede do nepravilnog rada kotla, ali i do ugrožavanja zdravlja ljudi pa i njihovih života. Najveća opasnost je od otrovnih gasova koji su produkti sagorevanja. U ovakvim situacijama gde nisu dimovod i dimnjak, kao i dovod vazduha za sagorevanje odrađeni na način kako je u uputstvu navedeno, Radijator Inženjering ne može da preuzme odgovornost za neželjene posledice.**



1. Posuda za kondenz
2. T.komad
3. Dimovodna cev
4. Koleno M-Ž 90
5. Rozetna Ž-Ž
6. Rozetna M-Ž
7. Koleno M-Ž 90
8. Zidni nosač
9. Kapa

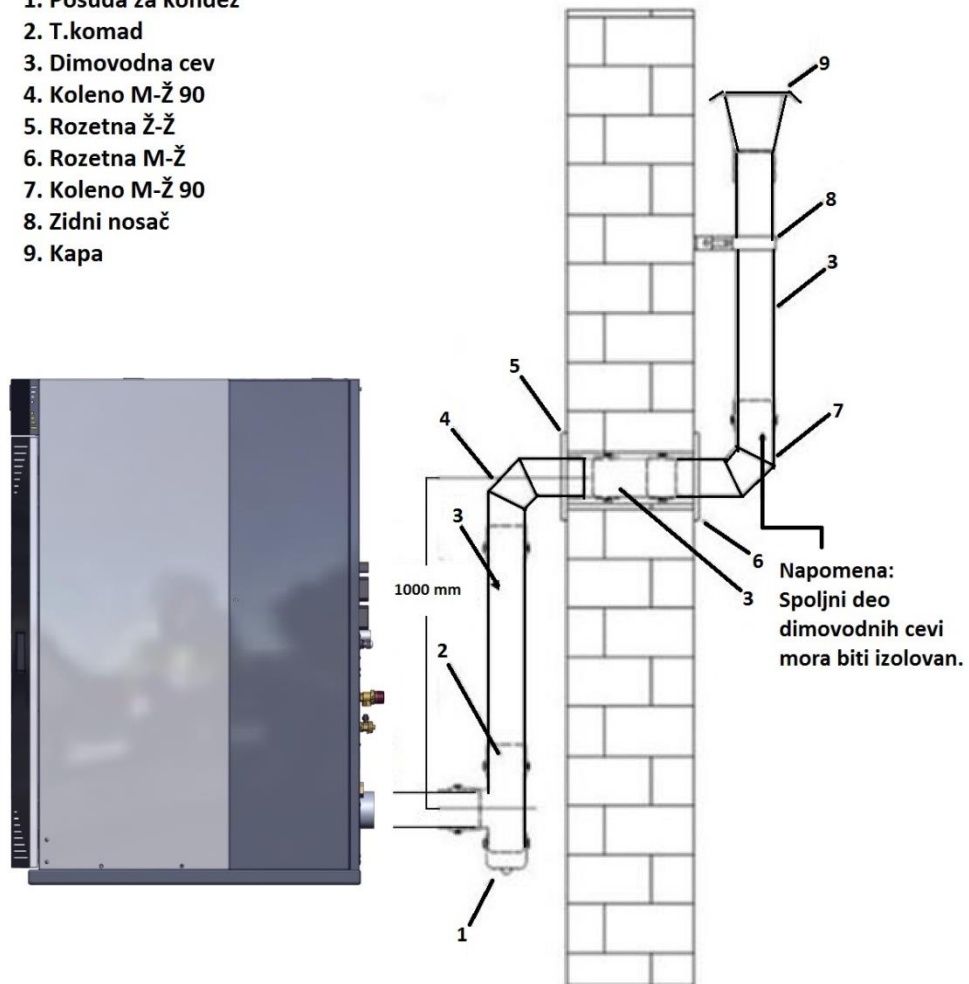

*Slika 12. Prikaz montaže dimovodnih kanala*

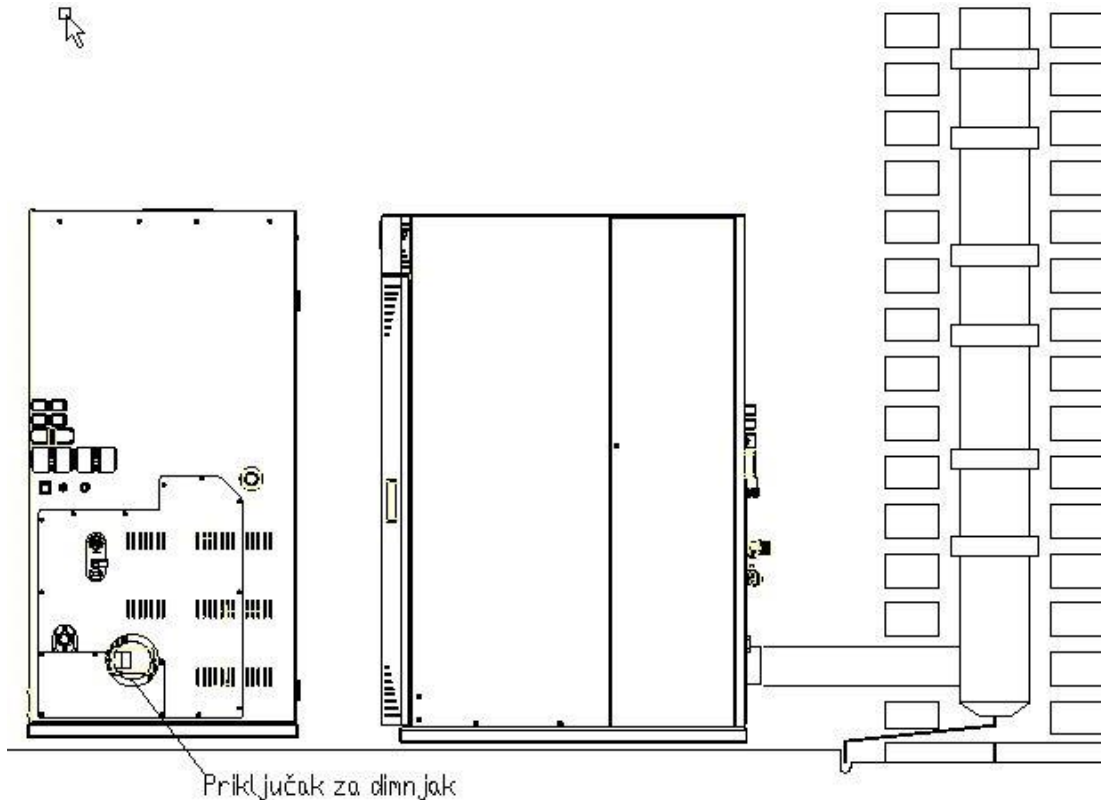

*Slika 13 . Prikaz priključenja na dimnjak*

Treba izbegavati ako je moguće lukove, a ako nije onda je maksimalni broj lukova (2).

Dimni kanal od kotla do dimnjaka poželjno je izolovati, posebno ako ima lukova i dužih deonica. U kućištu ventilatora izduvnih gasova fabrički je ugrađena sonda dimnih gasova. Pre puštanja u rad proveriti da li je posle transporta još uvek na svom mestu, jer bez pravilno postavljene sonde nema ni rada kotla.

Sam dimnjak treba da je napravljen od keramičkih cevi, oko njih treba da je izolacija debljine 3-5cm i zadnji spoljni sloj je cigla ili specijalni dimnjački elementi. Ako dimnjak ipak nije od keramike već od cigle, površina svetlog preseka takvog dimnjaka mora da bude 30% veća nego ovakva površina keramičkog dimnjaka.

Dimnjak mora da ima i vratanca za čišćenje a ona moraju dobro da dihtuju. Izlaz dimnjaka na krovu mora da bude po određenim propisima. Razlikuju se dva slučaja: ako je ugao krova manji od  $12^\circ$  i ako je ugao krova veći od  $12^\circ$ . Za ugao manji od  $12^\circ$  visine dimnjaka iznad krova je 1m a za ugao veći od  $12^\circ$  treba pogledati *sliku 14*.

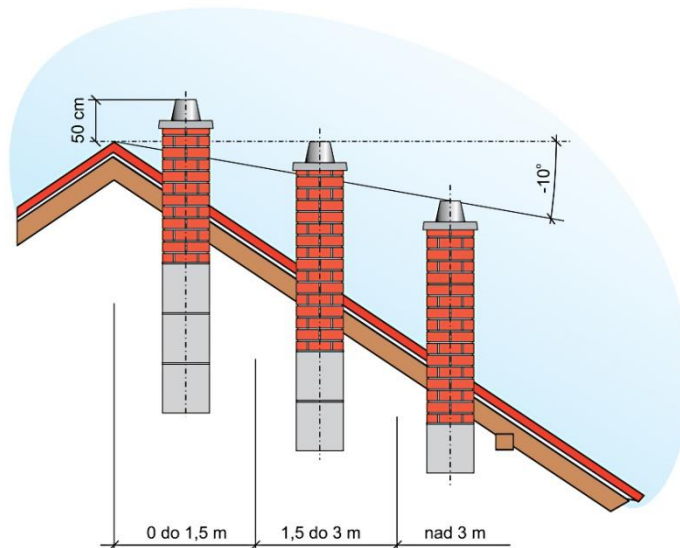

*Slika 14. Preporuka pri gradnji dimnjaka*

Ukoliko mislite da je dimnjak prejak i da isuviše hladnog vazduha prolazi kroz kotao, na izlazu iz kotla postoji klapna kojom može da se smanji protok izduvnih gasova. Dimnjak treba redovno da se čisti ili barem jedanput godišnje.



***Ukoliko dimnjak nije propisne visine, poprečnog preseka ili ako se ne čisti moguće su komplikacije u radu kotla. Pre svega nije moguć visokotemperaturni režim rada, tj. nema maksimalne radne snage, a posledice toga je pojava kondenzacije što utiče na radni vek kotla.***



***Slab dimnjak je glavni razlog da u toku potpale kotla ili u toku rada imamo pojavu dima na gornjim ili donjim vratima, naročito pri većim brojevima obrtaja ventilatora.***

## 4. Šema vezivanja automatike

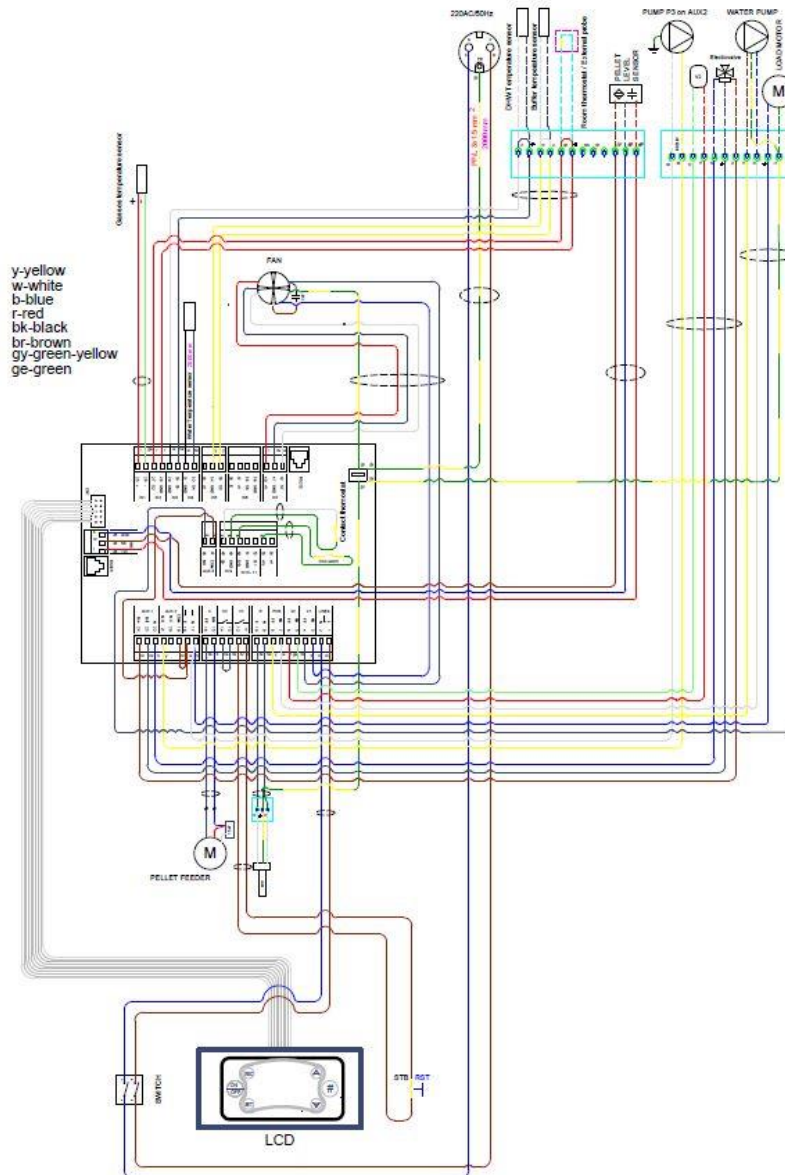

Slika 15. Šema povezivanja automatike



Za sobne termostate bitno je da budu sa baterijskim napajanjem tj. da nemaju na sebi bilo kakav dovod napona 220V. Na samom termostatu za povezivanje se koristi NC (normalno zatvoreni kontakt).



Kotao može da radi i u slučaju da nije priključena pumpa za centralno grejanje, ali preporuka proizvođača je da se ona ipak priključuje jer ima funkciju sigurnosnog elementa. Uključuje se kada temperatura vode u kotlu preraste 90°C.

## 5. Tabela sa tehničkim podacima

TIP KOTLA		<i>Ecoflame</i> <b>25</b>	<i>Ecoflame</i> <b>30</b>
CE oznaka		CE	CE
Klasa kotla po EN 303-5:2012		5	5
Radni pritisak	<i>bar</i>	2	2
Probni pritisak	<i>bar</i>	4,5	4,5
Zapremina vode u kotlu	<i>L</i>	81	81
Masa kotla	<i>kg</i>	375	375
Minimalni poprečni presek dimnjaka	<i>mm</i>	130	130
Potrebna promaja dimnjaka	<i>mbar / Pa</i>	0,12/12	0,12/12
Temperatura kotla (min / max)	<i>°C</i>	60-90	60-90
Minimalna temperatura povratnog voda	<i>°C</i>	60	60
Stepen iskorišćenja pri nominalnoj/minimalnoj toplotnoj snazi	%	92,35/92,82	91,98/92,53
Nominalna snaga	<i>kW</i>	25,27	29,97
Minimalna/ Maksimalna snaga kotla	<i>kW</i>	8,5/25,27	11/29,97
Emisija ugljen monoksida (CO) pri minimalnoj toplotnoj snazi (10% O <sub>2</sub> )	<i>mg / m<sup>3</sup></i>	366,3	360,3
Emisija ugljen monoksida (CO) pri nominalnoj topl.snazi (10% O <sub>2</sub> )	<i>mg / m<sup>3</sup></i>	131,85	124,63
Emisija prašine pri nominalnoj/minimalnoj toplotnoj snazi (10% O <sub>2</sub> )	<i>mg / Nm<sup>3</sup></i>	13,37/23,32	12,65/22,32
<b><i>Dimenzije</i></b>			
	<i>A</i>	690	690
	<i>B</i>	1355	1355
	<i>C</i>	935	935
	<i>C1</i>	1000	1000
	<i>φD</i>	100	100
Priključak za toplu vodu iz kotla	<i>D1</i>	1"	1"
Priključak za hladnu vodu u kotlu	<i>D2</i>	1"	1"
Priključak za punjenje i pražnjenje	<i>D3</i>	1/2"	1/2"
Priključak za ventil sigurnosti	<i>D4</i>	1/2"	1/2"
Priključak za odzračivanje	<i>D5</i>	1/2"	1/2"
Priključak za ventil termičkog osiguranja oticanjem VTO	<i>D6</i>	1/2"	1/2"
Priključci za sondu VTO	<i>D7</i>	1/2"	1/2"

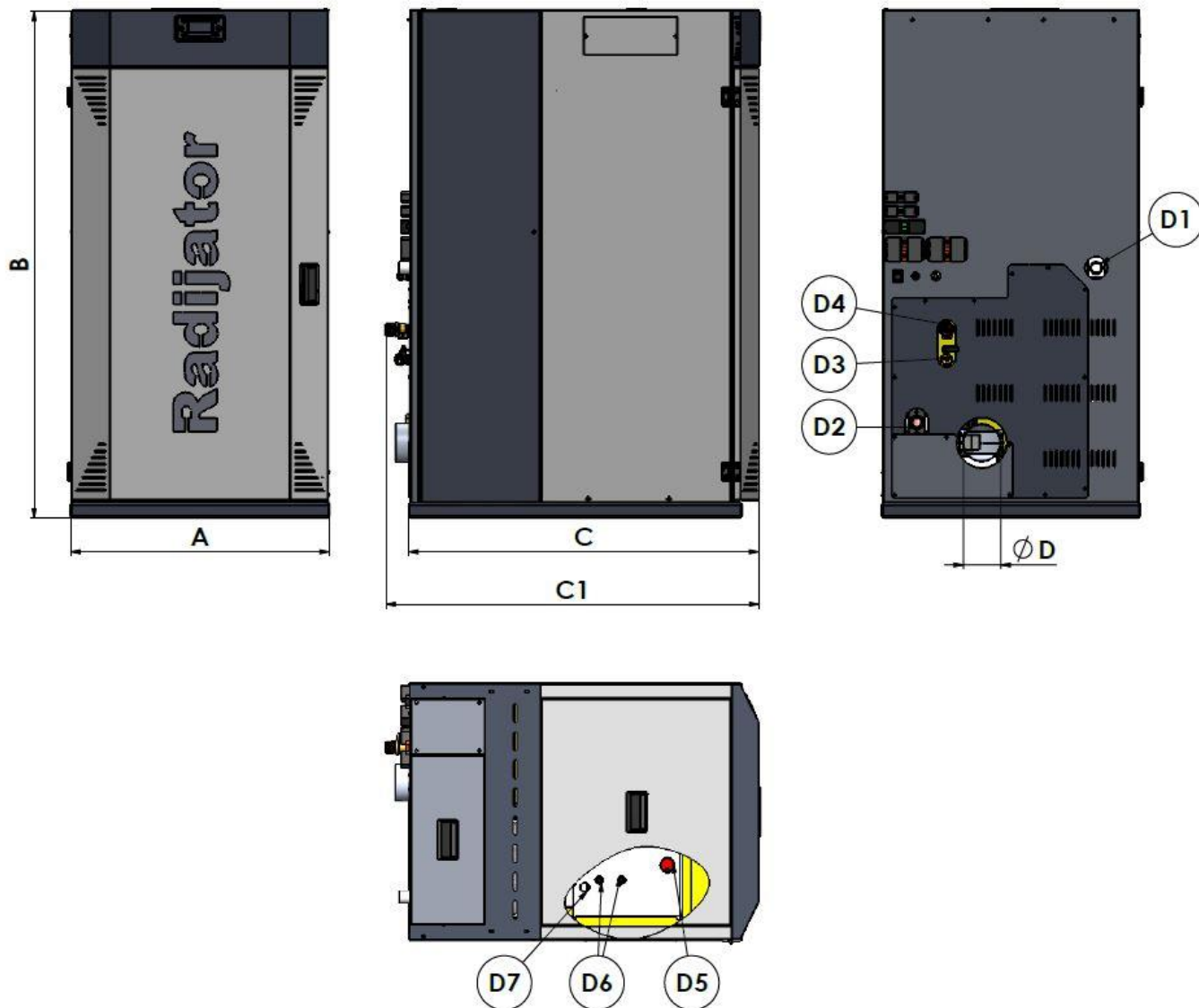

*Slika 16. Projekcije kotla sa dimenzijama*

## 6. Hidraulička šema

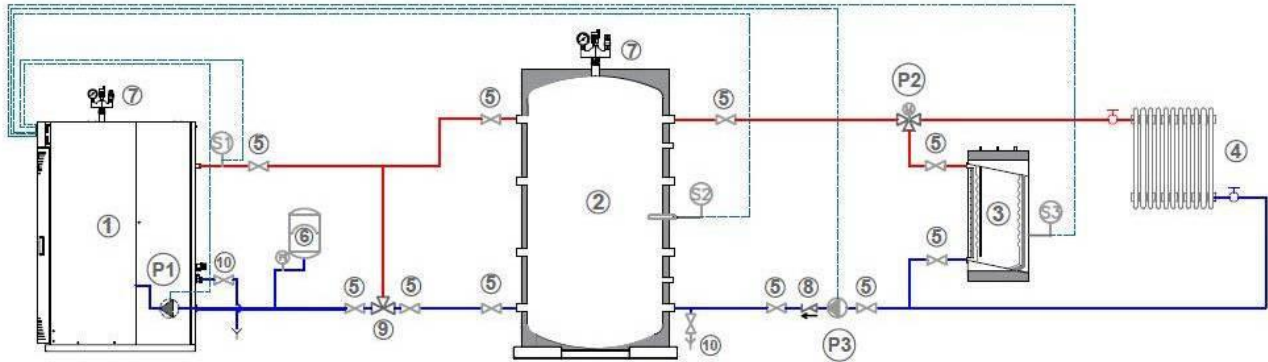



Slika 17. Hidraulička šema

LEGENDA	
1.	Toplovodni kotao <i>Ecoflame Plus 25kW</i>
2.	Akumulacija
3.	Bojler za sanitarnu vodu
4.	Izmenjivač
5.	Kugla ventil
6.	Zatvorena ekspanziona posuda
7.	Sigurnosna grupa (ventil sigurnosti+manometar+odzračni ventil)
8.	Nepovratni ventil
9.	Ručni trokraki ventil
10.	Slavina za punjenje i pražnjenje
P1	Pumpa
P2	Trokraki preklopni ventil sa EM pogonom
P3	Pumpa
S1	Sonda za merenje temperature
S2	Sonda za merenje temperature u akumulaciji
S3	Sonda za merenje temperature u bojleru

 **UPOZORENJE!**

 Prilikom montaže na hidrauličku instalaciju kotao mora biti obezbeđen na propisan način od prekoračenja maksimalne radne temperature i pritiska.

 Za propisnu montažu odgovoran je instalater centralnog grejanja koji priključuje kotao na hidraulički sistem.

 Radijator inženjering, kao proizvođač kotla, ne preuzima nikakvu odgovornost za štete prouzrokovane lošim instaliranjem kotla.

## 7. Start rada kotla i održavanje



**Prvo puštanje kotla u rad obavlja tehničko lice koje ima sertifikat izdat od strane Radijator inženjeringa. Obavezna je obuka korisnika kotla.**

Na taj način to lice je ovlašćeno da prijavi servisnoj službi u samoj fabrici vreme kada je kotao počeo da radi i u kakvom je stanju kotao bio prilikom prvog paljenja, dok kopiju izveštaja o puštanju kotla u rad zadržava. Garancija i uputstvo za upotrebu se daje kupcu. Jedan primerak garancije se šalje proizvođaču.

Ako garancija nije ispunjena, ona nije važeća.

Samo kotlovi koji su pušteni u rad od strane ovlašćenog tehničkog lica podležu uslovima garancije.

Naredni tekst je namenjen samom korisniku kotla, kao jedna vrsta podsetnika, da ako ugasi kotao (npr. zbog čišćenja) bude u stanju da samostalno pokrene kotao.



Parametri vezani za rad kotla a koji su dostupni korisniku su na samom displeju.

Ostale parametre koji su u tzv. skrivenom meniju ne treba menjati bez saglasnosti tehničkog lica koje je pustilo kotao u rad ili same fabrike.

### 7.1. LCD 100 displejom

#### Uvod

Glavni ekran pokazuje:

- 1 Snaga sagorevanja;
- 2 Recept sagorevanja;
- 3 Trenutna temperatura vode u kotlu;
- 4 Zadana temperatura vode u kotlu;
- 5 Status ili greška u radu sistema;
- 6 Funkcionalno stanje u kome se kotao nalazi;
- 7 Sat/Vreme;
- 8 Hrono režim rada kotla je aktiviran.

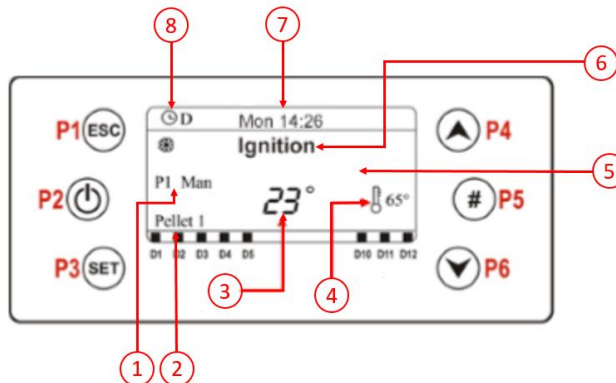

Slika 18. LCD 100 Displej

Radijator Inženjering d.o.o, 36000 Kraljevo, Živojina Lazića - Solunca br.6, Srbija  
tel. +381 36 399 140, fax. +381 36 399 150, <http://www.radijator.rs>  
e-mail: [radijator@radijator.rs](mailto:radijator@radijator.rs)



<b>Dugme</b>	<b>Funkcija dugmeta</b>
P1	Izlaz iz menije i podmenija;
P2	Start kotla i gašenje (držati 3 sec), reset greške (držati 3 sec), omogućiti/onemogućiti hrono;
P3	Ulazak u korisnički meni 1/podmeni, ulazak u korisnički meni 2 (držati 3 sec), sačuvati promenjenu vrednost;
P4	Ulazak u meni za nadzor sonde, u podmenijima uvećava vrednost promenljive;
P5	Omogućava hrono režim;
P6	Ulazak u meni za nadzor sonde, u podmenijima umanjuje vrednost promenljive.
<b>Led</b>	<b>Funkcije</b>
D1	Grejač kotla je uključen;
D2	Dozer je uključen;
D3	Pumpa kotla je uključena;
D4*	Elektro-ventil je uključen;
D5	Izlaz za start pomoćnog izvora je aktivan;
D6*	Pumpa 3 je aktivna;
D7*	Motor na pomoćnom silosu je aktivan;
D8	
D9**	Eksterni hrono je postignut;
D10*	Senzor za nivo peleta je odreoovao;
D11*	Sobna temperatura je postignuta;
D12*	Zahtev za sanitarnu vodu je aktivan.
*Potrebno je instalirati dodatnu opremu koja nije u obimu isporuke osnovne verzije. Za sve informacije kontaktirajte ovlašćenog servisera.	

Automatika ima mogućnost dijagnostike smetnji i problema u radu. Svako abnormalno stanje automatika signalizira porukom na ekranu i preuzimanjem odgovarajuće akcije. Poruka koje se pojavljuju na ekranu delimo u dve grupe, a to su:

- Greške i
- Ostale poruke.

### **Greške**

Greške su poruke koje signaliziraju problem u radu sistema. Karakteriše ih oznaka Err i sistem odlazi u gašenje, a zatim u blokadu. To znači da je sistem blokiran i onemogućeno je ponovno startovanje sistema dok se problem ne ukloni.

Er01	Sigurnosni termostat je odreoovao. Temperatura vode u kotlu je previsoka. Sistem signalizira grešku i kada je ugašen.
Er02	Sigurnosni termostat je odreoovao. Temperatura vode u kotlu je previsoka. Sistem

	signalizira grešku samo kada je kotao u radnom režimu.
Er03	Temperatura dimnih gasova je preniska.
Er04	Temperatura vode u kotlu je previsoka.
Er05	Temperatura dimnih gasova je previsoka.
Er07	Problem sa enkoderom ventilatora dimnih gasova, odnosno automatika ne dobija signal sa enkodera.
Er08	Problem sa enkoderom ventilatora dimnih gasova. Ventilator dimnih gasova ne može da postigne zadati broj obrtaja.
Er11	Greška u vremenu. Signalizira problem sa satom realnog vremena.
Er12	Neuspela potpala.
Er15	Gašenje zbog nestanka struje.
Er16	RS485 Komunikaciona greška
Er18*	Sistem se gasi zbog nedostatka peleta.
Er23	Jedna od sonde kotla je u kvaru/prekidu.
Er56	Problem sa konfiguracijom distribucije vode, više u odeljku Menadžment distribucijom vode.

U slučaju pojavljivanja grešaka koje nisu definisane tabelom. Pozvati ovlašćenog servisera. Greške označene sa \* se odnose na dodatnu opremu, koja nije u osnovnom obimu isporuke.

### ***Ostale poruke***

Sond (Sonda)	Pokazuje status temperaturnog senzora. Odnosno kada je očitavanje sonde jednako minimalnoj ili maksimalnoj vrednosti koju sonda može da očitati. Poruka je prikazana u toku faze potpale. Preporučuje se da se proveri veza sonde sa automatikom.
Service (Servis)	Poruka se prikazuje jer je kotao radio unapred definisan broj sati i potrebno je pozvati servisera radi redovnog servisa.
Clean (Čišćenje)	Poruka se prikazuje jer je kotao radio unapred definisan broj sati i potrebno je očistiti kotao.
Port (Vrata)	Vrata kotla su otvorena.
Link error (Greška u komunikaciji)	Greška u komunikaciji između ploče i kontrolne table.
Cleaninig on (Čišćenje)	Kotao radi sopstveno/automatski predviđeno periodično čišćenje.
Ignition Block	Poruka koja se ispisuje ako pokušate isključenje sistema u fazi potpale. Sistem će se isključiti tek posle ulaska u radni režim (Run mode).
Er06	Sigurnosni termostat na silosu je odreagovao.
Er20	U osnovnoj konfiguraciji nije predviđeno pojavljivanje ove grešaka. U slučaju pojavljivanja pozvati ovlašćenog servisera.

### ***Monitoring***

Da bi pristupili ekranu za monitoringu pritisnite dugme P4 ili P6:

<b>Exhaust T.</b>	Temperatura dimnih gasova [°C]
-------------------	--------------------------------

<b>Boiler T.</b>	Temperatura vode u kotlu [°C]
<b>Boiler Return T.*</b>	Temperatura vode u povratu [°C]
<b>Buffer T</b>	Temperatura vode u akumulaciji [°C]
<b>DHW T.</b>	Temperatura sanitarne vode [°C]
<b>Fan Speed</b>	Brzina ventilatora [rpm]
<b>Auger</b>	Vreme rada dozera [s]
<b>Product Code 549</b>	Kod proizvoda
*Ova vrednosti nije dostupna u standardnom obimu isporuke.	



### Korisnički meni 1

Da bi pristupili ovom meniju pritisnite dugme P3.

<b>Combustion Management</b>  (Upravljanje Sagorevanjem)	<b>Pellet power</b> Ovaj meni omogućava da se izabere da li će se regulacija snage vršiti automatski ili manuelno. Ako se izabere manuelno podešavanje snage korisnik mora izabrati i snagu sagorevanja.						
	<b>Auger Calibration</b> Meni za promenu vremena rada dozera. Sistem ima 10 kalibracionih koraka (0 je podešena fabrički). Kalibracioni efekat je vidljiv samo u Run mode i Modulation. Za svaki korak vrednost se uvećava procentualno za vrednost P15. Primer: P15=10%, Step=-1						
	<b>Podrazumevane vrednosti</b>	C03=2,0	C04=3,0	C05=4,0	C06=5,0	C07=6,0	C11=1,0
	<b>Kalibrisane vrednosti</b>	C03=1,8	C04=2,7	C05=3,6	C06=4,5	C07=5,4	C11=0,9
	<b>Fan Calibration</b> Meni za promenu vremena rada dozera. Sistem ima 10 kalibracionih koraka (0 je podešena fabrički). Kalibracioni efekat je vidljiv samo u Run mode i Modulation. Za svaki korak vrednost se uvećava procentualno za vrednost P16. Primer: P16=5%, Step=+3						
	<b>Podrazumevane vrednosti</b>	U03=100 0	U04=120 0	U05=140 0	U06=160 0	U07=180 0	U11=900
<b>Kalibrisane vrednosti</b>	U03=115 0	U04=138 0	U05=161 0	U06=184 0	U07=207 0	U11=103 0	

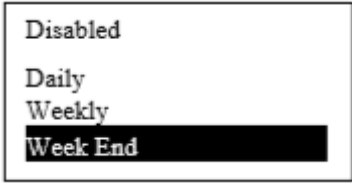
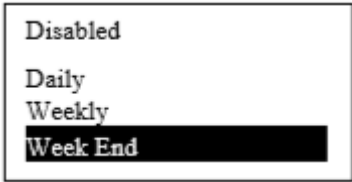
<b>Heating Management</b> (Upravljanje distribucijom vode)	<b>Boiler Thermostat (Temperatura vode u kotlu)</b> Meni koji omogućava promenu zadate temperature vode u kotlu. *Ako je omogućeno upravljanje senzorom spoljne temperature, ovaj meni nije dostupan jer se temperatura vode automatski izračunava.
	<b>Buffer Thermostat* (Temperatura u akumulaciji)</b> Meni koji omogućava podešavanje temperature vode u akumulaciji ili u gornjem delu akumulacije.
	<i>Bottom Buffer Thermostat**</i> <i>Meni koji omogućava promenu zadate temperature u donjoj polovini akumulacije.</i>
	<b>DHW Thermostat* (Temperatura sanitarne vode)</b> Meni koji omogućava promenu zadate temperature sanitarne vode.
	<i>Flow Thermostat*</i> <i>Meni koji omogućava promenu temperature u potisu kruga grejanja u kongiguraciji 9.</i>
	<i>Room Thermostat*</i> <i>Meni koji omogućava promenu zadate temperature u prostoriji kotla.</i>
	<b>Summer-Winter (Letnji ili zimski režim rada)</b> Letnji ili zimski režim rada kotla.
	<b>Climatic Function* (Senzor spoljašnje temperature)</b> Meni za podešavanja senzora spoljašnje temperature. Meni ima dva podmenija, Enable i Comfort Function. Enable: omogućava korisniku da isključi i uključi senzor spoljašnje temperature. Comfort Function: dozvoljava da se izvrši korekcija temperature za $\pm 20^{\circ}\text{C}$ . Senzor spoljašnje temperature radi samo u winter modu. Ako je funkcija omogućena na displeju se pojavljuje sledeći simbol  .
	<b>Mixer Valve*</b> <i>Meni koji omogućava upravljanje trokrakim mešnim ventilom. Korisniku je dostupan automatski režim rada. I forsirano otvaranje, odnosno zatvaranje.</i>
*Očitavanje ovih vrednosti zavisi od konfiguracije u kojoj kotao radi. Za više informacija obratiti se stručnom licu.	

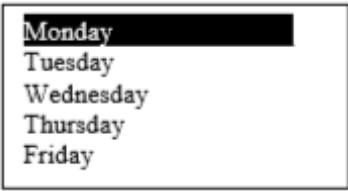
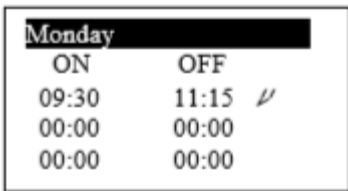
Load*	Ovaj meni omogućava ručno pokretanje dozera. Sistem mora biti u OFF režimu da bi se vršilo doziranje.	
Cleaning Reset*	Meni koji omogućuje resetovanje poruke clean.	
Hrono	<p>Meni koji omogućava hrono režim rada. Hrono režim rada je režim rada kotla koji omogućava paljenje/gašenje kotla po unapred definisanim režimu rada.</p> <p><b>Modality (način rada)</b></p> <p>Omogućava da izaberete željeni model rada hrono režima ili da onemogućite hrono režim rada.</p> <ul style="list-style-type: none"> <li>• Ulazite u modification mod pritiskom na dugme P3</li> <li>• Kretanjem gore ili dole (dugme P4 ili P5) izaberete željeni mod rada (dnevni, nedeljni ili vikend)</li> <li>• Omogućiti/onemogućite hrono model rada pritiskom na taster P2.</li> </ul> <p>Sačuvajte podešavanja pritiskom na taster P3.</p>	
	<p><b>Programiranje</b></p> <p>Sistem omogućava izbor tri načina rada:</p> <ul style="list-style-type: none"> <li>• Dnevni,</li> <li>• Nedeljni,</li> <li>• Vikend.</li> </ul> <p>Posle izbora željenog režima rada:</p> <ul style="list-style-type: none"> <li>• Izabrati dan u nedelji ili period koji želite da programirate pritiskom na tastere P4 ili P6.</li> <li>• Kada izaberemo period ulazimo u pod meni pritiskom na dugme P3.</li> <li>• Promenu vremena vršimo pritiskom na dugme P4 i P6.</li> <li>• Omogućiti (simbol pisano „V“ je prikazan pored intervala) vremenski interval pritiskom na dugme P5. Onemogućiti (simbol pisano „V“ nije prikazan pored intervala) vremenski interval pritiskom na dugme P5.</li> </ul>	

	<p><b>Programiranje intervala sa prelaskom u sledeći dan:</b></p> <ul style="list-style-type: none"> <li>• Primer: Želimo da se kotao uključi u utorak u 22:30h, a da se isključi u sredu u 06:30h.</li> <li>• Podesiti da se kotao uključi u utorak u 22:30h.</li> <li>• Podesiti da se kotao isključi u utorak u 23:59h.</li> <li>• Podesiti da se kotao uključi u sredu u 00:00h.</li> <li>• Podesiti da se kotao isključi u sredu u 6:30h.</li> <li>• Sistem će se uključiti u utorak u 22:30h, a isključiti u sredu u 6:30h.</li> </ul>	
	<p><b>Daily</b></p> <p>Birate dan u nedelji i podešavate vreme kada će se kotao isključiti, odnosno uključiti.</p>	
	<p><b>Weekly</b></p> <p>Program je isti za sve dane u nedelji.</p>	
	<p><b>Week-end</b></p> <p>Možemo programirati intervale za radne dane (izaberete Mon-Fri) i za vikend (izborom Sat-Sun).</p>	

### Korisnički meni 2

Dužim pritiskom na dugme P3 ulazimo u korisnički meni 2

<p><b>Keyboard Settings</b></p>	<p><b>Time and date</b> Podešavanje vremena i datuma.</p>
	<p><b>Language</b> Izbor jezika.</p>
<p><b>Display menu</b></p>	<p><b>Brightness</b></p>

	Osvetljenje ekrana
	<b>Minimum Light</b> Osvetljenje ekrana kada se ekran ne koristi (u mirovanju).
	<b>Sound</b> Omogućiti/onemogućiti akustičnu signalizaciju displeja.
	<b>Keyboard Address</b> Ovaj meni je zaštićen šifrom. I ne treba vršiti promenu u njemu.
	<b>Node list</b> Ovaj meni pokazuje komunikacione adrese, FW kod, FW verziju i td... Podatke nije moguće promeniti.
<b>System menu</b>	Za ulazak u meni je potrebna šifra. Podešavanja u sistem meniju su namenjena stručnim licima.

## 7.2. Funkcionalna stanja sistema

- Off - Sistem je isključen;
- Check up - Provera da li je sa sistemom sve u redu i da li može bezbedno preći u potpalu;
- Ignition - Potpala kotla;
- Stabilization - Režim rada između potpale i radnog režima. Uloga je da osigura stabilan rad kotla u radnom režimu;
- Recovery Ignition - Režim rada se aktivira pri potpali samo ako iz nekog razloga sistem prethodno nije regularno isključen (kabal je izvučen iz zida, duži nestanak struje i td);
- Run mode - Normalni režim rada, kotao još uvek nije postigao zadatu temperaturu;
- Modulation - Normalni režim rada, kotao je postigao zadatu temperaturu;
- Standby - Kotao je u stanju pripravnosti, spreman za start. Najčešće se koristi u kombinaciji sa sobnim termostatom;
- Safety - Sigurnosni režim rada. Kotao ulazi u ovaj režim samo ako je temperatura dimnih gasova ili temperatura vode previsoka;
- Extinguishing - Kotao se gasi;
- Block - Automatika je detektovala nepravilnost u radu sistema.

## 7.3. Senzor za detektovanje otvorenih vrata kotla

- Standardni deo opreme kotla je senzor na vratima kotla. Senzor detektuje da li su vrata kotla otvorena i šalje signal automatici. U slučaju da otvorite vrata u toku rada kotla, automatika kotla će preuzeti sledeće akcije:
  - o zaustaviti sistem za doziranje peleta;
  - o brzina ventilatora biće maksimalna;
  - o na displeju automatike će se pojaviti poruka port/door/vrata.
- Nakon zatvaranja vrata kotao nastavlja svoj normalni rad.
- Automatika ispisuje poruku port/door/vrata i u OFF režimu (odnosno kada je kotao isključen).

Ovim merama predostrožnosti se sprečava vraćanje plamena kroz vrata kotla i garantuje bezbednost korisnika.

## 7.4. Termostat za nadzor temperature peleta

- Standardni deo opreme kotla je i senzor za nadzor temperature peleta. U slučaju da temperatura peleta dostigne kritičnu vrednost, automatika kotla preuzima sledeće akcije:
  - o sistem za doziranje peleta staje;
  - o ventilator mora da ostane isključen;
  - o isključuje grejač (ako je u tom trenutku bio uključen);
  - o ispisuje poruku na ekranu Er06.

Ovim merom predostrožnosti se podiže nivo bezbednosti sistema.

## 7.5. Instaliranje dodatne opreme

### 7.5.1. Uvodne napomene

Podšavanja i povezivanje dodatne opreme izvode samo stručna lica.

Broj ulaza i izlaza na automatici je ograničen. Pri izboru dodatne opreme pažljivo razmotrite Vaše prioritete sa stručnim licem. Ne može se instalirati svu dodatna oprema jednovremeno. Napravite prioritete. Na raspolaganju Vam stoje tri temperaturna ulaza, ulaz za senzor nivoa pelata, dva izlaza koji se mogu koristiti u različite namene (njihovo ponašanje se programira parametrima), izlaz za elektro ventil i izlaz za pumpu kotla.

Svaki izlaz automatike ima jednoznačno definisano maksimalno trajno strujno opterećenje.

Maksimalno jednovremeno trajno strujno opterećenje automatike je 6.3A. Maksimalno opterećenje po jednom izlazu je 3A. Fabrički instalisana snaga je 420W, odnosno 1,8A.

Instalater dodatne opreme je dužan da vodi računa o strujnim ograničenjima pojedinačnih izlaza kao i o maksimalnom jednovremenom opterećenju automatike.

U sledećim situacijama:

- o maksimalno jednovremeno opterećenje prelazi 6,3A;
- o pojedinačni izlaz je preopterećen;
- o potreban Vam je trofazni potrošač;

naša preporuka je korišćenje releja ili kontaktora odgovarajućih karakteristika.

### 7.5.2. Sobni termostat ili senzor spoljnje temperature

Nije moguće istovremeno instalirati sobni termostat i senzor spoljašnje temperature.

#### 7.5.2.1. Sobni termostat

Ulaz za sobni termostat je beznaponski kontakt.

Povezivanje: Ukloniti briku u konektoru i povezati termostat prema šemi povezivanja.



### 7.5.2.2 Senzor spoljašnje temperature

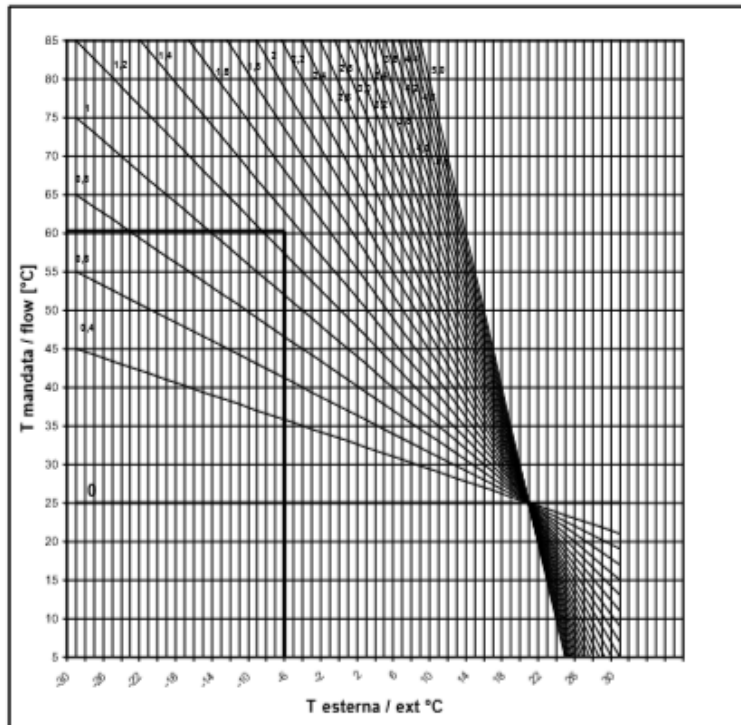

**Slika 19. Senzor spoljašnje temperature**

Senzor spoljašnje temperature nije moguće instalirati u konfiguraciji 10.0

Senzor spoljašnje temperature je moguće instalirati uz šemu 10.1; 10.2 i 10.3.

Senzor spoljašnje temperature nije moguće instalirati zajedno sa sobnim termostatom.

#### **PRINCIP RADA:**

##### **Sistemi bez akumulacije**

Temperatura u kotlu je automatski izračunata i varira u opsegu od  $T_{h26}$  do  $T_{h27}$ . Kalkulacija se vrši na osnovu krive. Izbor krive se vrši podešavanjem parametra P60. Naša preporuka za parametar P60=1.

##### **Sistem sa akumulacijom**

Temperatura u akumulaciji se automatski izračunava po sistemu opisanom iznad. Dok se temperatura vode u kotlu izračunava kao suma temperature u akumulaciji i parametra D11. Izbor krive se vrši podešavanjem parametra P60. Naša preporuka za parametar P60=1.

##### **Senzor spoljašnje temperature i konfiguracija 10.1**

Izmena parametara:

P74 [konfiguracija senzora spoljašnje temperature]=7

P26 [potvrda konfiguracije]=0

##### **Senzor spoljašnje temperature i konfiguracija 10.2**

Izmena parametara:

P74 [konfiguracija senzora spoljašnje temperature]=7

P26 [potvrda konfiguracije]=2

### ***Senzor spoljašnje temperature i konfiguracija 10.3***

Izmena parametara:

P74 [konfiguracija senzora spoljašnje temperature]=7

P26 [potvrda konfiguracije]=4

### ***Povezivanja***

Senzor spoljašnje temperature povezati na izlaz Room thermostat kako je prikazano na šemi.

### **7.5.3. Start rezervnog/dodatnog izvora toplote**

Ukoliko želite da imate rezervni izvor toplote (na primer gasni ili elektro kotao) automatika kotla može da vrši upravljanje (paljenje i gašenje) rezervnog izvora toplote.

**Princip rada:** Kada temperatura dimnih gasova padne ispod vrednosti (Th56) pri kojoj se kotao gasi, aktivira izlaz koji vrši uključenje pomoćnog izlaza. Kada temperatura dimnih gasova pređe zadatu vrednost automatika gasi izlaz.

**Šema povezivanja i parametri:** Za ovu funkciju moguće je koristiti izlaz V2. Izlaz je naponski 230V.

Parametri: u system menu u podmeniju enables parametaru P44 je fabrički podešen na vrednost 3.

Zatim u System menu u podmeniju Thermostats menu podesiti parametar Th56 i historezis Ih56. Naša preporuka je da parametar Th56 približno jednak parametru Th35, a parametar Ih56 bude između 2 i 10°C.

### **7.5.4. Dodatni sistem za doziranje peleta**

Potrebno je povezati senzor za nivo peleta i motor sistema kao što je prikazano na šemi.

Princip rada: Kada senzor za nivo peleta da signal, aktivira se izlaz koji pokreće motor za punjenje silosa. Ako je posle vremena T24 signal senzora za nivo peleta i dalje aktivan automatika gasi kotao i pokazuje grešku Er18.

T23 je vreme koje se dopunjuje silos nakon signala senzora.

U system menu podesiti sledeće parametre:

Enable: P71=2

Timers: T23 i T24 (naša preporuka za parametre je sledeća T23=1900; T24=1800).

## **7.6. Menadžment distribucije vode**

### **7.6.1. Uvodne napomene**

Ulazi na automatici za temperaturne senzore, prilagođeni su sondama NTC 10K. Konfiguracija 10.0 je podrazumevana i fabrički učitana. Konfiguracije 10.1; 10.2; 10.3 se automatski dobijaju iz konfiguracije 10.0 i nije potrebno vršiti parametrizaciju. Parametri su navedeni i namenjeni su isključivo stručnim licima.

### **Greška Er56**

Pri promeni konfiguracije moguća je pojava greške Er56.

U tom slučaju treba postupiti na sledeći način:

1. proverite parametre;
2. ugasite kotao: OFF stanje;
3. isključiti napajanje;
4. proverite ožičenje;
5. uključiti napajanje;
6. proverite u monitoringu da li su očitavanja sonde u redu;
7. ponovite postupak ako je potrebno.

### 7.6.2 Konfiguracija 10.0

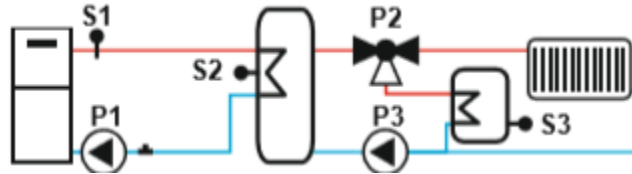

Slika 20. Konfiguracija 10.0

Ako želite konfiguraciju kao na slici prvo podesiti parametar P26=10.

#### Princip rada

##### Zaštita od smrzavanja

Da bi se izbegla smrzavanje vode, ako temperatura vode padne ispod unapred definisane vrednosti (Th18), pumpa P1 i P3 se aktiviraju, a ventil P2 naizmenično menja položaj.

##### Radni režim (Run mode)

Sistem zagreva vodu u akumulaciji ako je temperatura vode u kotlu veća od Th19 i ako je razlika temperatura vode u kotlu i akumulaciji veća od Th57.

Sistem zagreva vodu u bojleru sanitarne vode ako je temperatura u bojleru sanitarne vode manja od Th79 i ako je razlika temperature u akumulaciji i bojleru sanitarne vode veća od Th81.

Kada se zagreje i voda u bojleru sanitarne vode (Th79), ako sobna temperatura (ako je instalisan sobni termostat) nije dostignuta i ako je temperatura u akumulaciji veća od zadate (Th59) sistem omogućava radijatorsko grejanje.

##### Visoke temperature (Pregrevanje sistema-sigurnosna funkcija)

Ako je temperatura vode veća od unapred definisane vrednosti (Th21 ili Th25) iz sigurnosnih razloga se aktivira pumpa P1. Ako je temperatura vode u akumulaciji veća od unapred definisane vrednosti (Th78), pumpa P3 se uključuje i ventil otvara krug grejanja sanitarana voda. Ako je temperatura vode veća od Th80, ventil otvara krug grejanja P2.

Preporučene vrednosti parametara: **Th18**=5°C, **Th19**=40°C, **Th21**=75°C, **Th58**=60°C, **Th78**=70°C, **Th79**=55°C, **Th80**=65°C, **Th81**=5°C, **Th59**=50°C

##### Zaštita od smrzavanja

Sonda S1	Sonda S2	Sonda S3	Dif. 1-2	Dif. 2-3	Pumpa P3	Pumpa P1	Elektro ventil P2
T<5°C	-	-	-	-	ON	ON	Krug grejanja je isključen

##### Radni režim

Sonda S1	Sonda S2	Sonda S3	Dif. 1-2	Dif. 2-3	Pumpa P3	Pumpa P1	Elektro ventil P2
T<40°C	-	-	-	-	OFF	OFF	Krug grejanja je isključen
T≥40°C	-	-	>5°C	≤5°C	OFF	ON	Krug grejanja je isključen
T≥40°C		T<55°C	>5°C	>5°C	ON	ON	Krug sanitarne vode je uključen
T≥40°C	T<50°C	T≥55°C	>5°C	-	OFF	ON	Krug grejanja je isključen
T≥40°C	T≥50°C	T≥55°C	>5°C	-	ON	ON	Krug grejanja je isključen
<i>Visoke temperature (Pregrevanje sistema-sigurnosna funkcija)</i>							
Sonda S1	Sonda S2	Sonda S3	Dif. 1-2	Dif. 2-3	Pumpa P3	Pumpa P1	Elektro ventil P2
T≥75°C	T<70°C	T<65°C	-	-	OFF	ON	Krug sanitarne vode je uključen
T<75°C	T≥70°C	T<65°C	-	-	ON	OFF	Krug sanitarne vode je uključen
T<75°C	T<70°C	T≥65°C	-	-	ON	OFF	Krug grejanja je isključen
T≥75°C	T≥70°C	T≥65°C	-	-	ON	ON	Krug grejanja je isključen

Kratkim spajanjem ulaza temperaturnih sondi iz konfiguracije 10 možemo dobiti još tri pojednostavljena sistema distribucije vode.

#### Ožičenje:

Povezati sondu sanitarne vode [DHW Temperature sensor] na konektor kao što je prikazano na šemi.  
Povezati sondu akumulacije vode [Buffer temperature sensor] na konektor kao što je prikazano na šemi.  
Povezati pumpu P3 [Pump P3] na konektor kao što je prikazano na šemi.  
Povezati elektroventil [Electro valve] na konektor kao što je prikazano na šemi.

#### Parametri:

*Fabrički su podešeni.*

Sledeći parametri se nalaze u system menu zatim enables:

P26[izbor konfiguracije]=10;

P75[sonda sanitarne vode]=8;

P76[sonda bafera]=9;

P36[konfiguracija pumpe]=14

Parametri **Th18, Th19, Th21, Th58, Th78, Th79, Th80, Th81, Th59** se nalaze u system menu → Thermostats menu i treba ih prilagoditi prema potrebama korisnika i uputstvu iznad.

### 7.6.3 Konfiguracija 10.1

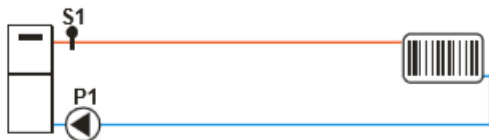

*Slika 21. Konfiguracija 10.1*

### Princip rada:

Preporučene vrednosti parametara:

**Th18**=5°C; **Th19**=40°C; **Th21**=70°C

Upravljanje krugom grejanja

Pumpa je aktivna ako je temperatura vode u kotlu iznad unapred definisane vrednosti Th19. Da bi se izbeglo zamrzavanje pumpa je uključena i kada je temperatura vode ispod Th18. Ako temperatura vode pređe vrednost Th21 iz bezbednosnih razloga se pumpa uključuje.

### Ožičenje:

Izlaz za sondu sanitarne vode [DHW Temperature sensor] na konektor kratko spojiti.

Izlaz za sondu u akumulaciji [Buffer temperature sensor] na konektor kratko spojiti.

### Parametri:

*Fabrički su podešeni.*

Sledeći parametri se nalaze u system menu zatim enables:

P26[izbor konfiguracije]=10;

P75[sonda sanitarne vode]=8;

P76[sonda bafera]=9;

P36[konfiguracija pumpe]=14

Parametri **Th18**, **Th19**, **Th21** se nalaze u **system menu** → **Thermostats menu** i treba ih prilagoditi prema potrebama korisnika i uputstvu iznad.

## 7.6.4 Konfiguracija 10.2

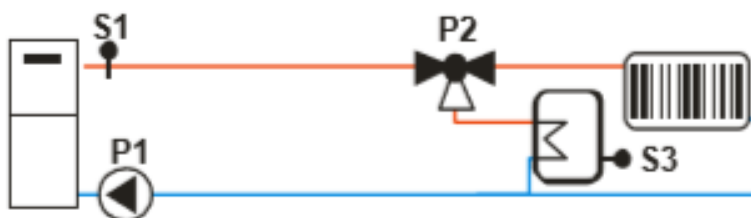

Slika 22. Konfiguracija 10.1

### Princip rada:

*Upravljanje krugom grejanja*

Pumpa P1 je uključena ako temperatura vode u kotlu prelazi vrednost Th20 termostata, a temperatura vode u baferu ne prelazi unapred definisanu vrednost Th79 i razlika između očitane temperature sa sondom S1 i S3 sonde su veće od Th57 termostata. Pumpa je uključena ako je temperatura vode u kotlu veća od Th19 termostata. Da biste izbegli smrzavanje, pumpa je uključena ako je temperatura vode u kotlu ispod Th18 termostata. Ako temperatura vode u kotlu premašuje vrijednost Th21 termostata iz sigurnosnih razloga, pumpa je uvek uključena.

*Upravljanje krugom sanitarne vode*

Ako je temperatura u bojleru sanitarne vode niža od Th79 i ako je temperature u kotlu veća od Th20 i razlika temperature vode u kotlu i sanitarne vode Th57, ventil P2 je otvoren. Ako je temperature vode u kotlu dostigla vrednost Th21 ventil P2 se isključuje.

Preporučena vrednost parametara: Th18=5°C, Th19=65°C, Th20=50°C, Th21=70°C; Th57=5°C; Th79=55°C.

Sonda S1	Sonda S3	Mod	Razlika Temp.	Ventil P2	Pumpa P1
T<5°C				Krug grejanja je isključen	ON
5°C≤T<50°C				Krug grejanja je isključen	OFF
50°C≤T<65°C	T<55°C		<5°C	Krug grejanja je isključen	OFF
			≥5°C	Krug sanitarne vode je uključen	ON
	T>55°C		<5°C	Krug grejanja je isključen	OFF
		Zimski režim	≥5°C	Krug grejanja je isključen	OFF
	Letnji režim	≥5°C	Krug sanitarne vode je uključen	ON	
65°C≤T<70°C	T<55°C		<5°C	Krug grejanja je isključen	OFF
			≥5°C	Krug sanitarne vode je uključen	ON
	T>55°C	Zimski režim		Krug grejanja je isključen	ON
		Letnji režim	<5°C	Krug sanitarne vode je uključen	OFF
	Letnji režim	≥5°C	Krug sanitarne vode je uključen	ON	
T≥70°C				Krug grejanja je isključen	ON

### Ožičenje:

Izlaz za sondu sanitarne vode [DHW Temperature sensor] povezati na konektor kao što je prikazano na šemi.

Izlaz za sondu u akumulaciji [Buffer temperature sensor] na konektor kratko spojiti.

Povezati pumpu P3 [Pump P3] na konektor kao što je prikazno na šemi.

Povezati elektroventil [Electro valve] na konektor kao što je prikazno na šemi.

### Parametri:

Fabrički su podešeni.

Sledeći parametri se nalaze u system menu zatim enables:

P26[izbor konfiguracije]=10;

P75[sonda sanitarne vode]=8;

P76[sonda bafera]=9;

P36[konfiguracija pumpe]=14

Parametri Th18, Th19, Th20, Th21, Th57, Th79 se nalaze u system menu → Thermostats menu i treba ih prilagoditi prema potrebama korisnika i uputstvu iznad.

### 7.6.5. Konfiguracija 10.3

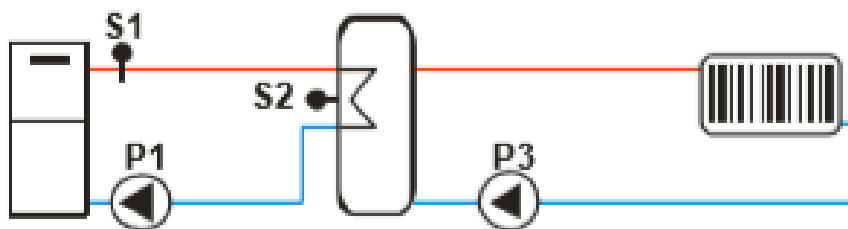

Slika 23. Konfiguracija 10.1

#### Princip rada:

Ako je temperatura u kotlu veća od  $Th_{19}$  i ako je razlika temperatura između dve sonde veća od  $Th_{57}$ , sistem zagreva vodu u akumulaciji. Pumpa P3 se uključuje ako je u baferu postignuta temperatura  $Th_{59}$ .

Zaštita od zamrzavanja i pregrevanja je opisana iznad.

Primer i preporučene vrednosti:  $Th_{18}=5^{\circ}\text{C}$ ,  $Th_{19}=40^{\circ}\text{C}$ ,  $Th_{21}=70^{\circ}\text{C}$ ,  $Th_{57}=5^{\circ}\text{C}$ ,  $Th_{59}=50^{\circ}\text{C}$ .

S1 sonda	Diferencijal	P1 pumpa
$T < 5^{\circ}\text{C}$		
$T < 40^{\circ}\text{C}$		
$T \geq 40^{\circ}\text{C}$	$< 5^{\circ}\text{C}$	OFF
	$\geq 5^{\circ}\text{C}$	ON
$T \geq 70^{\circ}\text{C}$		ON

S2 sonda	Mod	P3 pumpa
$T < 50^{\circ}\text{C}$		OFF
$T \geq 50^{\circ}\text{C}$	Winter	ON
	Summer	OFF

#### Ožičenje:

Izlaz za sondu u akumulaciji [Buffer temperature sensor] povezati na konektor kao što je prikazano na šemi.

Izlaz za sondu sanitarne vode [DHW Temperature sensor] na konektor kratko spojiti.

Povezati pumpu P3 [Pump P3] na konektor kao što je prikazno na šemi.

Povezati elektroventil [Electro valve] na konektor kao što je prikazno na šemi.

#### Parametri:

Fabrički su podešeni.

Sledeći parametri se nalaze u system menu zatim enables:

$P26[\text{izbor konfiguracije}]=10;$

$P75[\text{sonda sanitarne vode}]=8;$

$P76[\text{sonda bafera}]=9;$

Radijator Inženjering d.o.o, 36000 Kraljevo, Živojina Lazića - Solunca br.6, Srbija  
tel. +381 36 399 140, fax. +381 36 399 150, <http://www.radijator.rs>  
e-mail: [radijator@radijator.rs](mailto:radijator@radijator.rs)

*P36[konfiguracija pumpe]=14*

*Parametri Th18, Th19, Th20, Th21, Th57, Th79 se nalaze u system menu → Thermostats menu i treba ih prilagoditi prema potrebama korisnika i upustvu iznad.*

#### 7.6.6. Spisak temperaturnih parametara/termostata

Šifra	Opis	Sonda	Jedinica
Th18	Zaštita od smrzavanja	S1	[°C]
Th19	Temperatura pri kojoj se uključuje pumpa 1	S1	[°C]
Ih19	Historezis termostata Th19	S1	[°C]
Th21	Temperatura pri kojoj se aktivira pumpa 1 iz sigurnosnih razloga	S1	[°C]
Ih21	Historezis termostata Th21	S1	[°C]
Ih24	Historezis 1	S1	[°C]
Th25	Maksimalna (sigurnosna) temperature vode u kotlu	S1	[°C]
Th26	Minimalna vrednost temperature koju korisnik može da zada u kotlu	S1	[°C]
Th27	Maksimalna vrednost temperature koju korisnik može da zada u kotlu	S1	[°C]
Th51	Minimalna temperatura koju korisnik može podesiti u akumulaciji	S2	[°C]
Th52	Maksimalna temperatura koju korisnik može podesiti u akumulaciji	S2	[°C]
Th57	Razlika temperature voda u kotlu i vode u akumulaciji	Dif.	[°C]
Ih57	Historezis termostata Th57	Dif.	[°C]
Ih58	Historezis sonde u akumulaciji	S2	[°C]
Th59	Temperatura pri kojoj startuj pumpa P2	S2	[°C]
Ih59	Historezis termostata Th59	S2	[°C]
Th60	Temperatura vode na povratu (važi samo za konfiguraciju 8)	Ret. Boler	[°C]
Ih60	Historezis termostata Th60	Ret. Boler	[°C]
Th78	Maksimalna (sigurnosna) temperature u akumulaciji	akumulacija	[°C]
Th80	Maksimalana (sigurnosna) temperature u bojleru sanitarne vode	Sanitarna voda	[°C]



Th81	Razlika temperature u akumulaciji i bojleru sanitarne vode	Dif. 2	[°C]
Ih81	Historezis Th81	Dif. 2	[°C]
Th83	Maksimalna temperatura koju korisnik može da zada u bojleru sanitarne vode	Sanitarna voda	[°C]
Th97	Razlika temperature u kotlu I sanitarne vode	Dif. 3	[°C]
Ih97	Historezis termostata Th97	Dif. 3	[°C]

### 7.7. Zaštita od blokade pumpe i trokrakog ventila

Ako pumpa kotla ne radi 24h automatika uključuje pumpu i trokraki ventil u trajanju od 2 minuta da bi se izbegla blokada.

### 7.8. Resetovanje na fabrička podešavanja

Sistem je moguće vratiti na fabrički učitane parameter.  
 System menu → Restore Parameter's factory value manu.

### 7.9. Puštanje u rad kotla

1. Kotao priključiti na hidrauličnu šemu;  
 U slučaju pojavljivanja greške Er56 pogledajte više na u poglavlju 6.1.1;
2. Uključiti kotao na napajanje; Obavezno uključiti i prekidač na zadnjoj strani oplata;
3. Koristeći funkciju manual load pustiti dozer da radi 15-20s;  
 Pritisnite dugme Set → load → yes → sačekajte 15-20s → isključite na NO;
4. Zatim pritiskom na dugme 3sec ON/OFF startovati kotao.

## 7.10. Održavanje kotla Ecoflame Plus

Kotao *Ecoflame Plus* zahteva svakodnevno i periodično čišćenje.

- Svakodnevno čišćenje se odnosi na prostor samog ložišta odnosno šolje za sagorevanje gde stalnim izbacivanjem pepela omogućavamo bolji rad elektro grejača za potpalu i bolje sagorevanje tj. veću količinu vazduha kroz proreze na šolji. Takođe pepeo već u toku dana počinje da se taloži na podu, prostoru oko samog ložišta. Pri prosečnim parametrima sagorevanja 100kg peleta proizvede 1kg pepela. Čišćenje se vrši vakumskim aparatom (usisivačem) za usisavanje pepela i to kada je kotao potpuno hladan. Na *slici 24* prikazana je demontaža šolje prilikom čišćenja.

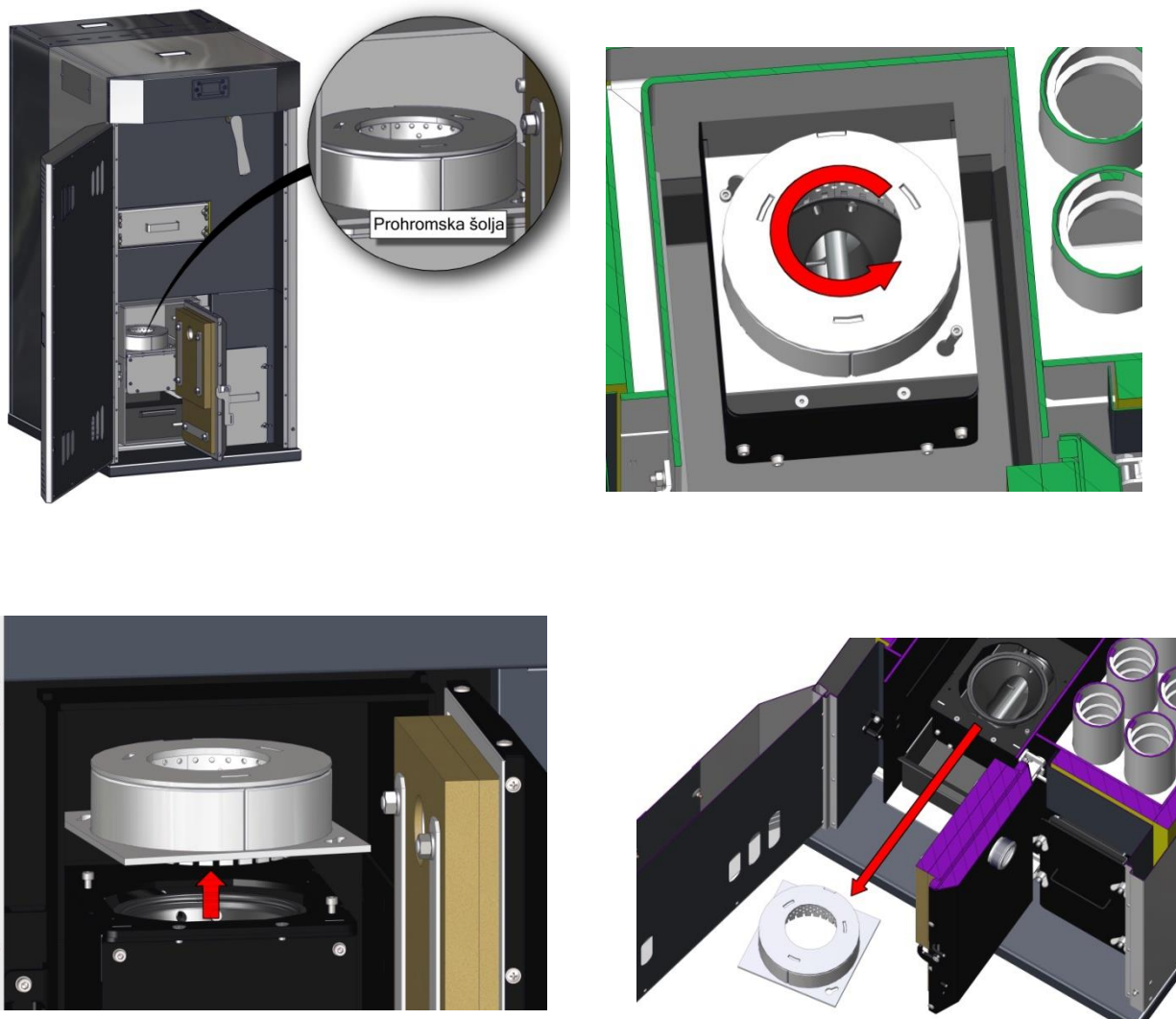

*Slika 24 . Demontaža prohromske šolje prilikom čišćenja*

- Svakodnevno čišćenje se odnosi i na pražnjenje pepeljare, (*slika 25*).

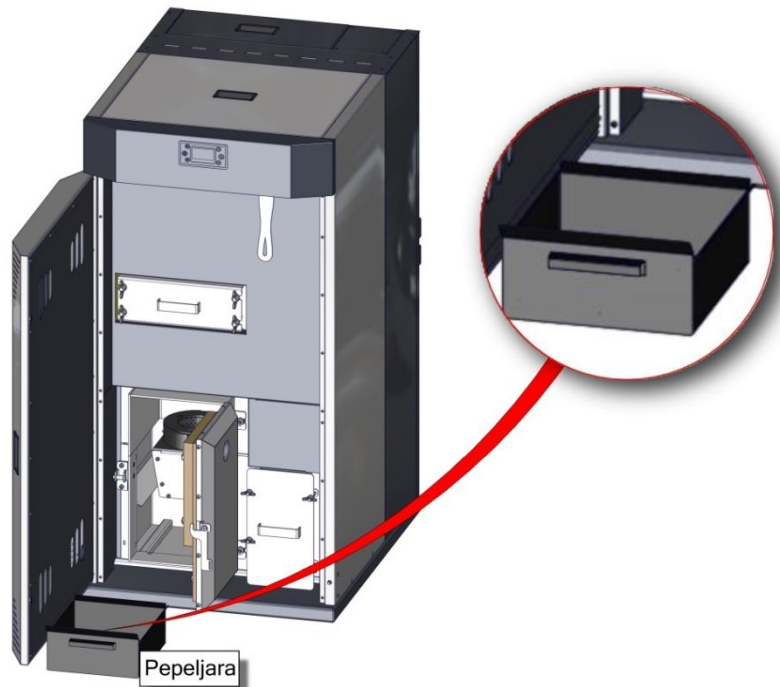

*Slika 25 . Prikaz kotla sa izvađenom pepeljarom*

- Periodično čišćenje kotla obuhvata čišćenje dimovodnih puteva unutar kotla. Da bi se ovo postiglo u samom kotlu su ostavljeni takozvani revizioni otvori za čišćenje. Ukupno ih ima 4, (*slika 26, 27*).
  - Otvoriti gornji poklopac za čišćenje, očistiti prostor oko mehanizma za čišćenje izmenjivačkih cevi; Prilikom redovnog servisa jednom godišnje moraju se i izvaditi turbulatori i sa celog tada dostupnog dela kotla skinuti katran i čađ.
  - Zatim skinuti poklopac sa revizionog otvora sa prednje strane dole u desnom uglu, očistiti ceo prostor ispod izmenjivačkih cevi;
  - Revizioni otvor iznad ložista se takodje čisti u ovom periodu, skinuti poklopac i usisivačem pokupiti katran i čađ;
  - Takođe u tom periodu treba otvoriti bočna vrata oplata i dimnjaču sa zadnje strane kotla očistiti od pepela i gareži. (**NAPOMENA: Obratiti pažnju na sondu dimovodnih gasova prilikom čišćenja dimnjače**).

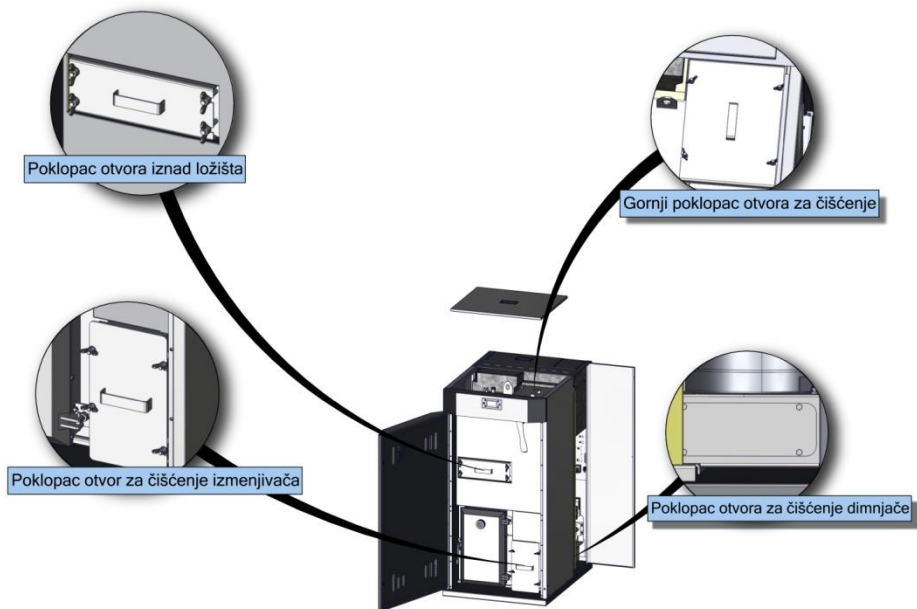

*Slika 26 . Poklopci revizionih otvora za čišćenje kotla*

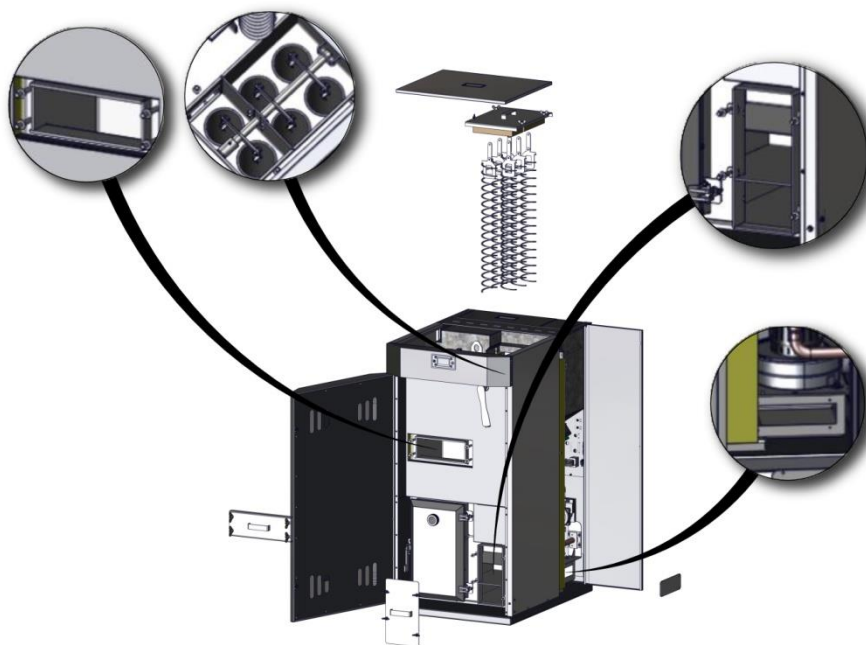

*Slika 27 . Prikaz revizionih otvora za čišćenje*

 ***Pri održavanju i servisiranju kotla, kotao isključiti sa napajanja.***

Ukoliko u kotlu, tokom korišćenja javi kondenzacija, potrebno je pokupiti kondenzat a ceo kotao iznutra premazati baznim sredstvima za čišćenje ili barem vodenim rastvorom građevinskog kreča. Na taj način se vrši neutralizacija kiselina usled kondenzacije.

 ***Na ovaj način obavezno konzervirati kotao na kraju grejne sezone. U toj situaciji zatvoriti i sve otvore na kotlu da ne dodje do cirkulacije vazduha kroz kotao jer i tako može doći do pojave vlage u kotlu.***

 ***Održavanje kotla je jedan od najbitnijih faktora za dužinu radnog veka kotla. Naročito je bitno da u van sezoni kotao bude očišćen i da se izvrši neutralizacija kiselina na već opisan način.***

## 10. Nalepnica

Na kotlu *Ecoflame Plus* nalaze se nalepnice za označavanje priključaka kao i nalepnice za opasnost od strujnog udara, nalepnice za šemu povezivanja i dr.

### Nalepnice koje označavaju priključke za povezivanje instalacije:

1. Nalepnica (Potisni vod) 32mm x 74mm



2. Nalepnica (Povratni vod) 32mm x 74mm

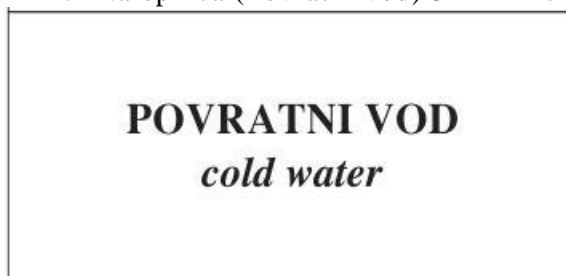

3. Nalepnica (Sigurnosna grupa) 32mm x 74mm



4. Nalepnica (Punjenje/pražnjenje) 32mm x 74mm

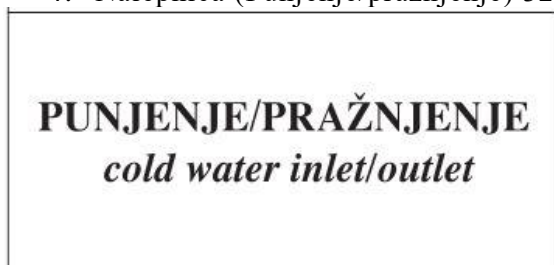

5. Nalepnica (Izmenjivač termičkog osiguranja) 32mm x 74mm



6. Nalepnica (Sonda termičkog osiguranja) 32mm x 74mm



7. Nalepnica (Šema povezivanja) 152mm x 210mm

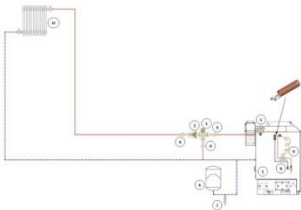

*Markovska linija*

Opis:

- |                            |  |
|----------------------------|--|
| 1. Toplinski klanj BH0000; | 6. Ekspanziona sonda;                  |
| 2. Prilaz;                 | 7. Sonda za temperaturno osiguranje;   |
| 3. Meha ventil;            | 8. Ventil termičkog osiguranja;        |
| 4. Ventil;                 | 9. Sonda ventila termičkog osiguranja; |
| 5. Sigurnosna grupa;       | 10. Izmerivač;                         |

**Nalepnice koje označavaju prisustvo struje, visokog napona i opasnosti:**

1. Nalepnica (Napon opasan po život) 60mm x 80mm



2. Nalepnica (Ulaz za sniženim naponom 12V) 60mm x 80mm



3. Nalepnica (Napon opasan po život - VEĆA) 100mm x 150mm



4. Nalepnica (Uzemljenje) 20mm x 30mm





5. Nalepnica (Prisustvo napona)



**Nalepnice koje označavaju upozorenje:**

1. Nalepnica (Izloženi pokretni delovi mogu izazvati povrede) 30mm x 80mm



2. Nalepnica (Obavezno poštanje u rad od strane ovlašćenog servisa) 65mm x 247mm



3. Nalepnica (Pažnja)



4. Nalepnica (Otpad)



## 11. Proizvođač



RADIJATOR D.O.O.  
Živojina Lazića Solunca br.6  
36000 Kraljevo, Srbija

## 12. Garancija

### 1. Radijator Inženjering pokriva različite garancijske periode za različite periode za različite delove (što je navedeno u daljem tekstu) samo ako su ispunjeni sledeći uslovi garancije:

1.1 Kotao mora biti priključen po navedenim hidrauličkim šemama iz tehničkog uputstva, naročito obratiti pažnju na sigurnosne ventile, termičko osiguranje oticanjem, opseg radnog pritiska, opseg radne temperature, uslove u kotlarnici itd.

1.2 Kotao mora biti priključen na dimnjak propisnog poprečnog preseka, karakteristika izolacije i visine.

1.3 Dimovod od kotla do dimnjaka mora biti izveden po tehničkom uputstvu.

1.4 Kod kotla moraju biti izvršena i navedena elektro priključenja iz tehničkog uputstva, naročito se misli na karakteristike sobnog termostata, karakteristike mrežnog napona koji mora biti u određenim granicama.

1.5 Korisnik mora da se pridržava navedenih uputstava o korišćenju i održavanju.

### 2. Garancijska izjava

Izjavljujemo:

1.1 da proizvod ima propisana i deklarirana kvalitetna svojstva. Obavezujemo se, da ćemo na zahtev kupca ako pravovremeno u garancijskom roku podnese zahtev za popravku, o svom trošku izvršiti sve popravke kvarova, tako da će proizvod raditi u skladu sa deklariranim svojstvima;

1.2 da će proizvod u garancijskom roku raditi besprekorno ako se budu poštovala uputstva za upotrebu, rad i montažu;

1.3 da ćemo u garancijskom roku biti spremni da otklonimo sve kvarove na proizvodu i držati na zalihama sve potrebne rezervne delove;

**1.4 garancijski rok počinje od DANA KUPOVINE I TRAJE 60 MESECI ILI 72 MESECA OD DATUMA PROIZVODNJE (datum proizvodnje nalazi se na nalepnici sa zadnje strane kotla)**

**1.5 GARANCIJA OD 60 MESECI VAŽI SAMO AKO SE KOTAO PREDOVNO SERVISIRA OD STRANE CENTRALNOG SERVISRA RADIJATOR INŽENJERINGA u periodu naznačenim za isti (dalje u tekstu)**

**1.6 Garancija važi ako je garantni list overen od strane prodavca i ako je upisan datum kupovine i priložen račun. TAKOĐE BITNO JE IMATI I NALOG A PUŠTANJE U RAD (overen od strane ovlašćenog servisera).**

### 3. Garancijski period od dve godine važi za sledeće delove:

Radijator Inženjering d.o.o, 36000 Kraljevo, Živojina Lazića - Solunca br.6, Srbija  
tel. +381 36 399 140, fax. +381 36 399 150, <http://www.radijator.rs>  
e-mail: [radijator@radijator.rs](mailto:radijator@radijator.rs)

- Za sve čaure-biksne;
- Elektro grejače za potpalu;

#### 4. Garancijski period od dve godine važi za sledeće delove:

- Lance za prenos obrtnog momenta 0.83;
- Donja i gornja pužna spirala;
- Ventilator na dimnjači;
- Automatika kotla sa sigurnosnim termostatom;
- Sonda dimnih gasova;
- Elektronska vodena pumpa sa priključcima;
- Sonda temperature kotlovske vode;
- Motor reduktor;
- T kanal gorionika sivi liv i čaura T komada;
- Elektro konektore
- Izolacije materijale na vratima i otvorima za čišćenje;
- Sigurnosni i odzračni ventil;
- Prohromska šolja.

#### 5. Garancijski rok ne važi:

- Ukoliko se posle svake grejne sezone ne odradi redovan servis;
- Za zamenu delova kod redovnog godišnjeg održavanja u skladu sa uputstvom;
- Kod kvarova koje je načinio kupac zbog nestručnog rukovanja proizvodom;
- Kod mehaničkih kvarova načinjenih prilikom transporta i prilikom korišćenja (čvrsti predmeti);
- Ako je proizvod instaliran nestručno, suprotno važećim propisima iz tog područja;
- Ukoliko se utvrdi da hidraulička šema nije urađena po preporukama firme „Radijator Inženjering“;
- Ako je kupac koristio proizvod iznad deklariranih svojstava i u normalnim okolnostima.

#### 6. Garancijski rok prestaje da važi:

- Ako se ustanovi da je kvarove otklanjala neovlašćena osoba ili neovlašćeni servis;
- Ako kod popravke nisu bili upotrebljeni i ugrađeni originalni delovi;
- Kad ističe garancijski rok;

#### 7. Kod prijave kvarova obavezno je dati sledeće podatke:

- Naziv i tip proizvoda;
- Datum kupovine;
- Fabrički ili radionički broj kotla;
- Kratak opis kvara, odnosno nedostatka;
- Tačnu adresu i kontakt telefon, mejl;

#### 8. Redovan godišnji servis:

Redovan servis se određuje na kraju svake grejne sezone u periodu od 15.4. do 31.8. i naplaćuje se utvrđenim cenovnikom firme „Radijator Inženjering“. Servisni postupak tehničkih lica koja obavljaju redovne godišnje servise, a koja su od strane proizvođača ovlašćena za to, obuhvataju sledeće operacije:

**NAPOMENA: serviser je dužan da pregleda sve navedene delove (sa liste) dozatora i izmenjivača i ukoliko dođe do zamene bilo kojih delova na iste korisnik dobija gore navedenu garanciju kao i garanciju na još 12 meseci na telo kotla (izmenjivača). Garancija se može produžiti do 5 god. od**

**datuma puštanja u rad. Servis i produženje servisa može da obavlja lice koje šalje centralni servis „Radijator Inženjering“-a. Na nezamenjene delove posle odrađenog servisa garancija ne važi.**

- Demontaža silosa za pelet od pelet transportera;
- Demontaža pelet transportera od kotla;
- Skidanje oba lanca;
- Demontaža gorionika za sagorevanje od ložišta i čišćenje prostora ložišta ispod gorionika.  
Provera stanja gorionika i zazora;
- Čišćenje gorionika;
- Čišćenje prostora cevi ložišta u kojoj se okreće donja pužna spirala;
- Provera ispravnosti dozirnog sistema;
- Izvaditi sondu dimnih gasova i očistiti je od naslaga;
- Provera ispravnosti ventilatora;
- Provera dihtovanja gornjih i donjih vrata;
- Provera održavanja kotlovskeg izmenjivača.

## Contents

1. Important warnings .....	57
1.1 Minimum separation distance from flammable materials .....	58
2. Description of the boiler .....	59
2.1. Cross-section of the Ecoflame Plus boiler with the description of elements .....	60
2.2. Construction.....	61
3. Assembly .....	64
3.1 General warnings .....	64
3.2. Measures and safety devices of the Ecoflame Plus boiler .....	65
3.3 Positioning of the Ecoflame Plus boiler in the boiler room .....	68
3.4 Connection to chimney .....	69
4. Connection scheme of automation system .....	73
5. Technical data table .....	74
6. Hydraulic scheme .....	76
7. Boiler start-up and maintenance .....	77
7.1 LCD 100 display .....	77
7.1.1 Introduction .....	77
7.1.2 Errors.....	79
7.1.3 Other messages.....	79
7.1.4 Monitoring .....	80
7.2. Functioning states of the system .....	84
7.3. Door sensor.....	84
7.4. Pellet thermostat .....	85
7.5. Installing additional equipment .....	85
7.5.1. Introductory notes .....	85
7.5.2. Room thermostat or outdoor temperature sensor .....	85
7.5.3. Start of an alternative/additional source of heat .....	87
7.5.4. Additional system for feeding pellets .....	87
7.6. Heating management .....	87
7.6.1 Introductory notes .....	87
7.6.2 Configuration 10.0 .....	88

7.6.3 Configuration 10.1 .....	90
7.6.4 Configuration 10.2 .....	90
7.6.5 Configuration 10.3 .....	92
7.6.6 List of temperature parameters/thermostats .....	93
7.7. Protection from blockade of the pump and the three-way valve .....	94
7.8. Resetting to factory settings .....	94
7.9. Boiler commissioning .....	94
7.10. Maintenance of the <i>Ecoflame Plus</i> boiler .....	94
8. Name plate .....	98
10. Sticker .....	100
11. Manufacturer .....	105
12. Warranty .....	105



## 1. Important warnings

### GENERAL WARNINGS

- After removing the packaging, make sure that the delivery is complete. In case of any shortcomings, address the dealer who sold the product.
- The boiler must be used exclusively for the purpose envisaged by the manufacturer. The manufacturer shall have no liability for damages to persons, animals or things in case of errors during assembly, regulation, maintenance or improper use.
- In case of water leakage, disconnect the device from the power supply, close the water supply and inform the authorised service and authorised installer.
- This instruction manual is an integral part of the device and must be kept with care and must **ALWAYS** accompany the device, even in case of change of the owner or user or in case of connection to another installation. In case it is damaged or lost, ask for a new copy from the authorised dealer.



### IMPORTANT WARNINGS

We hereby emphasize that the usage of a device using biomass and solid fuel, that has contact with electricity and water, demands observance of the following safety measures:

- Children and persons with limited capabilities who are unaccompanied are prohibited from using the boiler.
- It is forbidden to use the boiler on installations with working temperature above 110°C and working pressure higher than 3 bars.
- It is forbidden to use easily flammable fuel (alcohol, oil).
- It is forbidden to store easily flammable materials in the vicinity of the boiler and the firing door. The ashes must be disposed of in closed and non-flammable containers.
- It is forbidden to burn the waste or materials the combustion of which causes flame or explosion hazard (e.g. plastic bags, saw dust, coal dust, mud, etc.).
- Any intervention by a technician (this particularly refers to replacing heating elements or checking any other electrical device) or cleaning of the boiler is prohibited before the boiler has been disconnected from the power supply by taking out the plug from the main power supply.
- Any change to the safety elements is prohibited.
- It is forbidden to close the vents in the room in which the boiler is located. Vents are necessary for the proper combustion.
- It is forbidden to expose the boiler to harsh weather conditions. The boiler is not designed for outdoor use and does not contain a system against freezing.
- It is forbidden to turn off the boiler if the outdoor temperature may drop below ZERO (freezing hazard).
- In case of an intervention on any electrical device of the boiler, the boiler must be disconnected from the electrical wiring by taking out the plug from the power supply.

- Any work with the boiler device is prohibited to persons with disability (including children), either mental or physical, except with the supervision of a guardian or a person responsible for their acting.
- Children must be supervised by a guardian so as not to play with the boiler.
- If the power protection has been damaged, it must be replaced in the factory and serviced by an authorized service technician or qualified persons in order to avoid the risk of electric shock.

## 1.1 Minimum separation distance from flammable materials

- Ensure adequate distance from flammable materials, if necessary to secure protection of those materials.
- Minimum separation distance from flammable materials has been prescribed by the law – please ask the professional dealing with heating or chimney-sweepers.
- Minimum separation distance of the boiler and flue gas pipe from the low or averagely combustible materials should be at least 100mm.
- Minimum separation distance from easily flammable materials is 200mm, and the same applies for the materials flammability of which is unknown.



**Risk of fire!**

- Storing flammable materials and liquid in the vicinity of the boiler is prohibited.
- Warn the users about the required minimum separation distance between the boiler and flammable materials.

<b>Flammability of building materials</b>	
<b>A... Non-combustible</b>	Asbestos, stone, building stone, ceramic wall tiles, terracotta, plaster, screed (without organic additives);
<b>B... Not easily flammable</b>	Gypsum-cardboard plates, glass fibre, plates of AKUMINE, ISOMINE, RAYOLITE, LIGNOS, VELOX and HERACLITE
<b>C1... Low combustible</b>	Beech and oak wood, composite wood, felt, plates of HOBREX, VERSALITE and UMAKART
<b>C2... Average combustible</b>	Pine wood, larch wood, fir wood, composite materials;
<b>C3... Easily flammable</b>	asphalt, cardboard, cellulosic material, tar paper, chipboard, cork, polyurethane, polystyrene, polyethylene, polypropylene, polyethylene, floor fibres

## 2. Description of the boiler

- Boiler *Ecoflame Plus 25/30* was developed with the aim for Radijator Inženjering to offer to the market a boiler which, as per its mechanical and thermal properties, is intended for use of pellets as fuel.
- **If the user wishes to use some form of biomass that is not listed, he/she should contact the Construction and Development Department of Radijator Inženjering or the authorized dealer, since some forms of biomass often require specific combustion solutions.** Using the stated fuels implies automatic control of the main work parameters. In all stated examples of use of biomass, a certain fuel dryness level is required. On the other hand, market demands are such that they always seek more universal fuels.
- Wood pellets are produced from 100% cellulose. Wood residues are compressed under high pressure into pellets of 6mm in diameter and 2-3cm in length. Pellets should be appropriately stored in a dry place in order to ensure efficient combustion. Boiler *Ecoflame Plus 25/30* uses pellets of 6mm in diameter, 5-30mm in length and moisture up to 10%, produced as per the **EN 14962-2** standard. If the pellets are not produced as per the stated standard or its quality has deteriorated during the storing or transport, Radijator Inženjering, as the manufacturer, cannot have liability for the poor work of the boiler. In such situations, there might be errors in ignition, pellets might be piling up and falling out of the place for combustion, there might be insufficient power, etc.
- *Ecoflame Plus* is installed in the boiler room or other rooms, and it has an advantage in situations where more compact dimensions are required.
- It is assembled on a classic chimney of minimum 130mm in diameter. The chimney must meet all other standards as classic boilers. More on this may be found in the Assembly section.
- An adequate circulation pump has been installed in the boiler. The boiler is delivered with the safety valve and air vent. In addition to *Ecoflame Plus*, there is also a model *Ecoflame* which does not contain circulation pump, safety valve, filling and drainage tap.
- Adequate circular pump is installed within the boiler. The boiler is delivered with the safety and air vent.
- Pellet combustion is done as per the principle of volcanic fuel supply.
- The entire process is run by the automation system which allows the selection of one of two levels of power (25/30kW).
- It is possible to connect the room thermostat and set the periods of start of work and standby phases for 7 days.

## 2.1. Cross-section of the Ecoflame Plus boiler with the description of elements

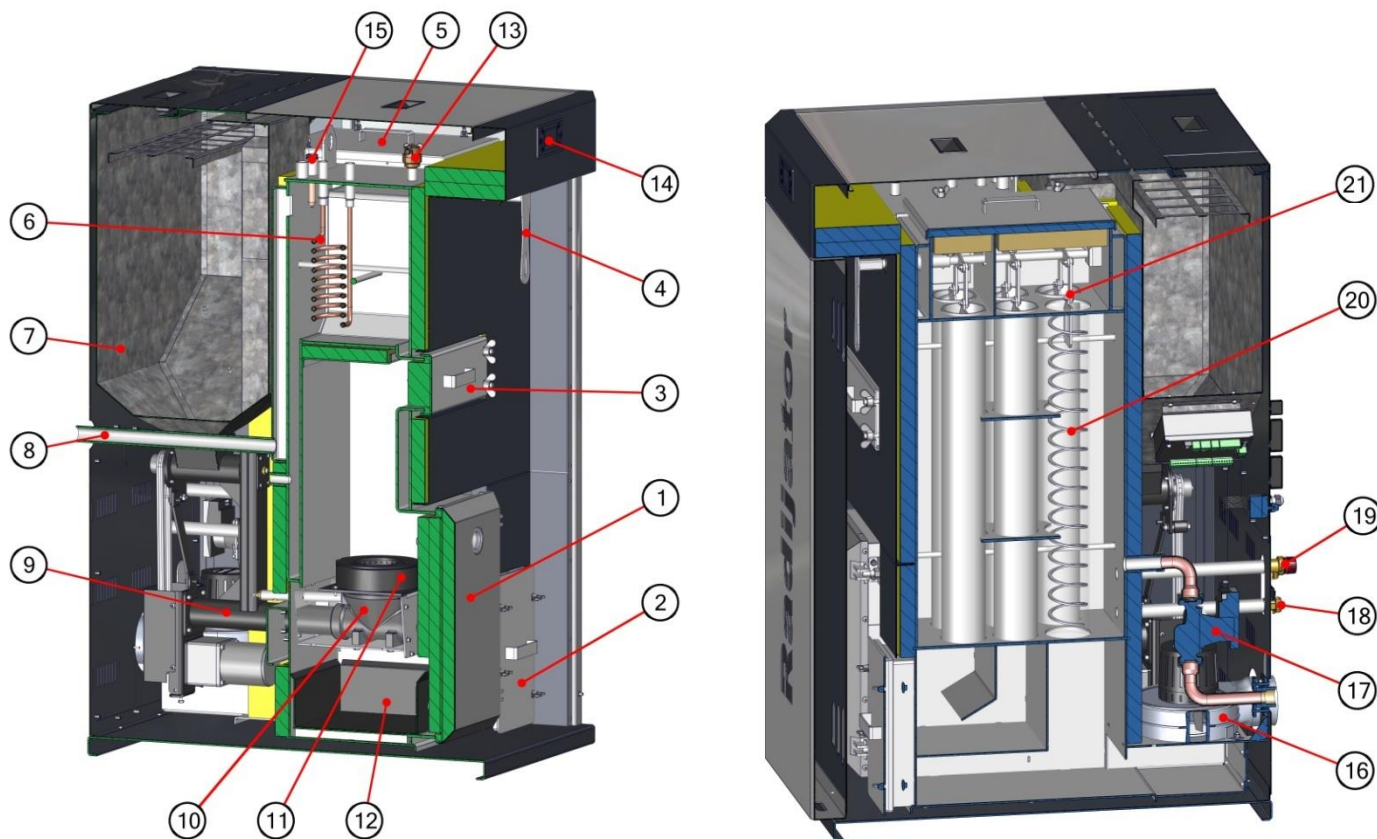

Picture 1. Cross-section of the Ecoflame Plus boiler

No.	Name
1	Door of the boiler;
2	Lower cover of revision opening for cleaning of the exchanger;
3	Upper cover of revision opening for cleaning above the combustion chamber;
4	Handle of the mechanism for cleaning the exchanger pipes;
5	Upper cover of revision opening for cleaning of the exchanger;
6	Thermal safety;
7	Silo;
8	Hot water connection;
9	Feeder;
10	Burner channel - T piece;

11	Chrome plated cup;
12	Ashtray;
13	Air vent;
14	Automation display;
15	Temperature sensor;
16	Ventilator, Ø100;
17	Electronic pump;
18	Filling and drainage tap;
19	Safety valve;
20	Turbulator for cleaning the exchanger pipes;
21	Mechanism for cleaning of the exchanger

## 2.2. Construction

As per the manner of combustion, boiler *Ecoflame Plus 25/30* belongs to the group of boilers in which the mass that burns springs into the combustion chamber.

Water portion of the boiler, its mode of heat exchange between flue gases and water, is adjusted to the use of biomass. All parts of the water portion of the boiler are made of seamless pipes of ST 35.4 quality and boiler plates 5mm thick. Plates are of **1.0425 EU** standard or **P265GH** standard **EUII**.

The exchanger is a three-draft exchanger made of vertically placed pipes. Owing to three-draft system of flue gases circulation, the boiler is highly efficient, resulting in saving energy and less pollution of the environment.

Inside the exchanger pipes, there are spiral turbulators with dual function. The first function is to increase the exchange of flue gases and heat exchanger, hence the efficiency of the boiler, while the second function is to mechanically clean the pipe walls. *Picture 2* shows the turbulators which move up-down by moving the handle left-right, thus cleaning the exchanger pipes. It is very important that this cleaning process is performed every day.

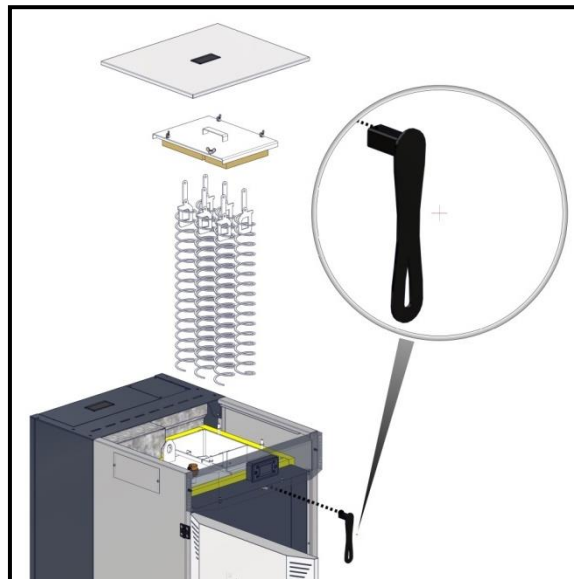

*Picture 2. Turbulators*

The efficiency level of the pellets is over 91%. Flue gases temperature values can be seen on the display at any time. During the work, the layers of soot and ash are piled on the boiler exchanger which results in significantly weaker exchange and the increase of flue gases temperature. If the boiler is not cleaned for a longer period of time, the flue gases temperature may rise so high that it enters into Modulation operating modality.

- The combustion chamber works as per the principle of “volcanic” fuel supply, where fuel, i.e. pellets, from silo rise into the feeder which transports it via two horizontal spirals in the combustion chamber zone, that is, to the burner channel, where the pellets pile up, the channel fills in and the pellets spring in the cup in which they burn. The cup is made of waterproof materials, *picture 3*.

Volcanic fuel supply

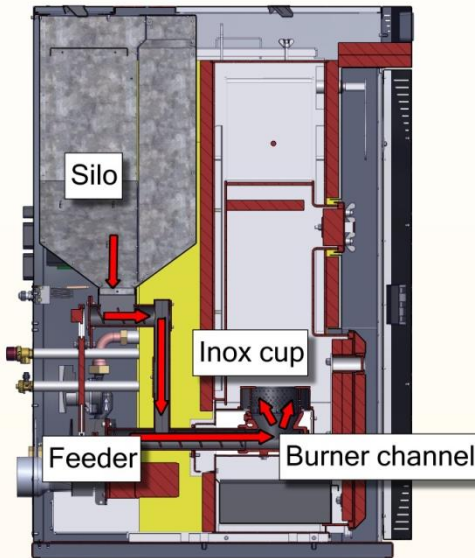

Picture 3. Volcanic fuel supply

Pellet combustion in the chrome plated cup is shown on *picture 4*. Openings above the red line are for secondary air, while the openings under the red line are for primary air. Red line shows the level of pellet combustion.

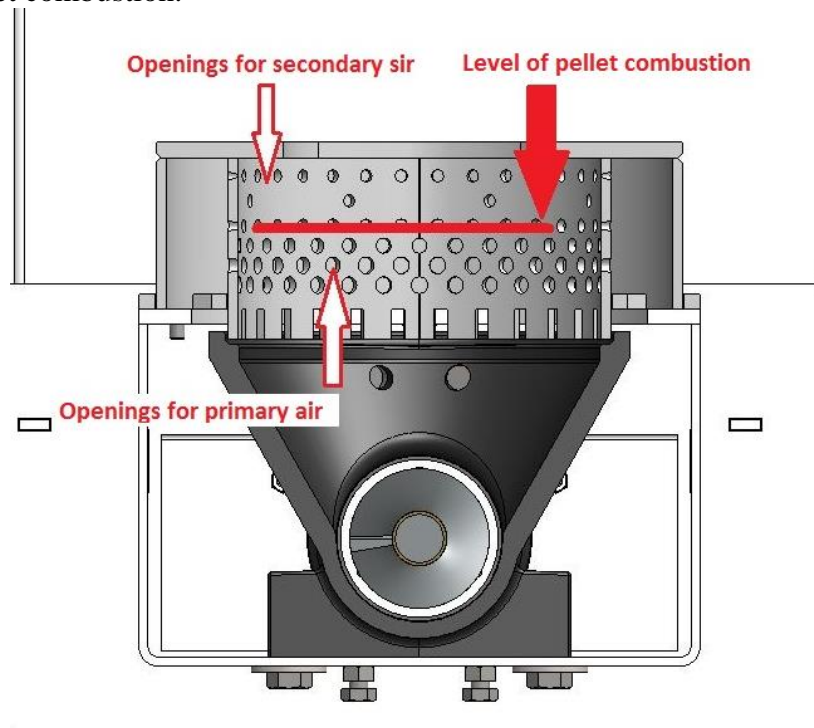

Picture 4. Pellet combustion in the chrome plated cup

The handle that moves the mechanism for cleaning turbulators is also used for opening the combustion chamber door, *picture 5*.

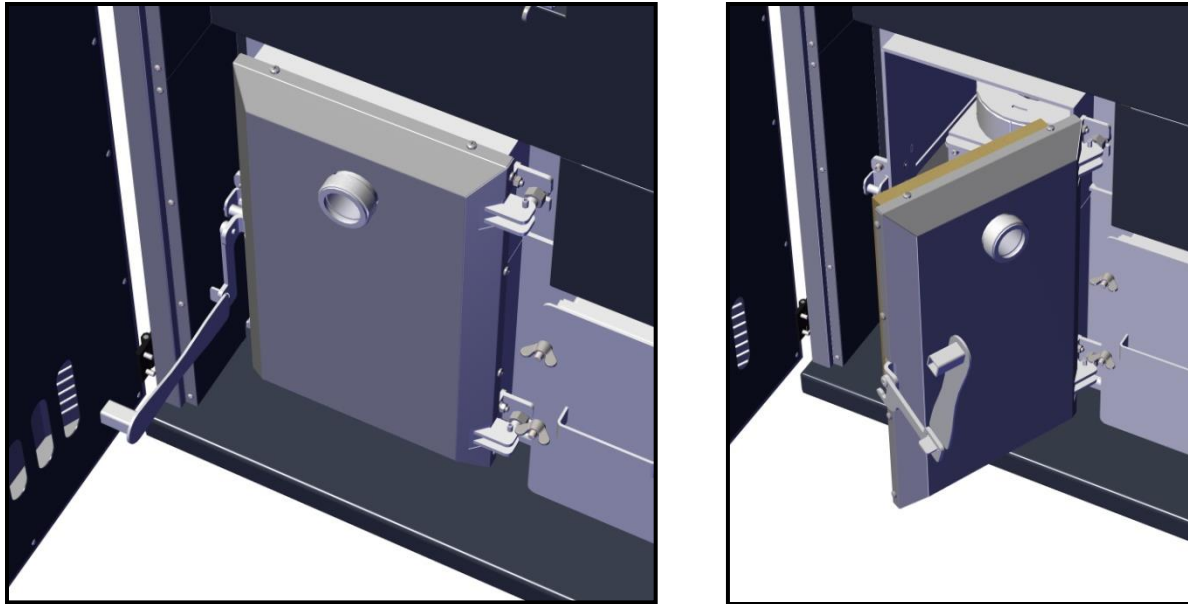

*Picture 5. Opening combustion chamber door*

- Capacity of silo is 65kg. There is a possibility of increasing capacity with additional silo for pellets, *picture 6*.



*Picture 6. Possibility of an additional silo, capacity 320kg*

Radijator Inženjering d.o.o, 36000 Kraljevo, Živojina Lazića - Solunca br.6, Srbija  
tel. +381 36 399 140, fax. +381 36 399 150, <http://www.radijator.rs>  
e-mail: [radijator@radijator.rs](mailto:radijator@radijator.rs)

## 3. Assembly

### 3.1 General warnings

The boiler must be positioned properly for proper operation!



Maximum working pressure of the boiler is 3 bars, minimum working pressure is 1 bar, while the maximum working temperature of the boiler is 110°C.



The boiler has a fan, automation system, electric heating element and all these devices use 230V power. Therefore, inadequate installation and careless handling may jeopardize human life through electric shock.



Solid fuel boiler and forced draft should be installed as per the norms and legal regulations in effect. Any change on either the mechanical construction or electric installations will be deemed a violation of terms of the warranty and will lead to its breach.



During the assembly on hydraulic installation, the boiler must be secured in the prescribed manner from exceeding the maximum working temperature and pressure.



Central heating installer who connects the boiler to the hydraulic system is responsible for the adequate assembly.



Radijator Inženjering, as the manufacturer of the boiler, shall have no liability for damages caused by inadequate boiler installation.



When doing any interventions on the electrical devices of the Ecoflame boiler, the entire system should be disconnected from the main power supply.



### 3.2. Measures and safety devices of the Ecoflame Plus boiler

The boiler is equipped with sophisticated safety devices which may stop the operation of the boiler in case of unforeseen circumstances, thus preventing any consequences that may be caused by improper operation of the boiler. Whenever a problem occurs, the devices will stop feeding pellets and the shutting down phase of boiler will begin.

- **Pressure safety valve;**
- **Air vent;**
- **Thermostats in the automation system that regulate the work of the boiler;**
- **Thermal safety valve (TSV) (the boiler has an envisaged connection for TSV on top, which is installed by the boiler user).**

#### Pressure safety valve, shown in picture 7 on the left

- Pressure safety valve must be of nominal 1/2" in diameter, calibrated to maximum 3 bars. This safety element which belongs to the group of pressure limiters must be of such construction to withstand short-term exceeding temperature and pressure, as well as certain content of glycol in the heating liquid.
- Safety valve is located on the back side of the boiler, outside the casing so that, if activated, the water it lets out does not endanger the work of the boiler.
- Safety valve must be mounted on the boiler without any pipeline or any other elements in between. For this purpose there is a specially designed connector. Any reduction in diameter of the connector is strictly forbidden.
- Drain or exhaust part of the safety valve must be of pipes the diameter of which is at least equal to the nominal diameter of the outlet part of the valve. Furthermore, for its production it is allowed to use, at most, one arc of radius  $r > 3d$ .
- Safety valve must possess a nameplate with the following data:
  - name of the manufacturer;
  - designation of the type of safety valve/year of testing;
  - nominal flow rate;
  - data stating for which thermal effect the safety valve is set;
  - the highest opening pressure, i.e. 3 bars.
- It is obligatory to check the proper functioning at regular intervals, as well as to have it calibrated again by a certified company. These obligations are carried out in accordance with the law of each country in which the boiler is assembled. Always keep the written documentation containing the data of the latest calibration of the safety valve.
- Assemble at least one more pressure safety valve on the cold water connection.

#### Air vent, shown in picture 7 on the right

- Air vent is assembled on the highest point of the boiler. This is another safety measure that refers to appearance of air in the system and boiler itself. It also absorbs sudden momentary pressure changes. It can withstand maximum pressure of 10 bars. This safety element must be periodically calibrated again, of which the boiler user must possess valid documentation.

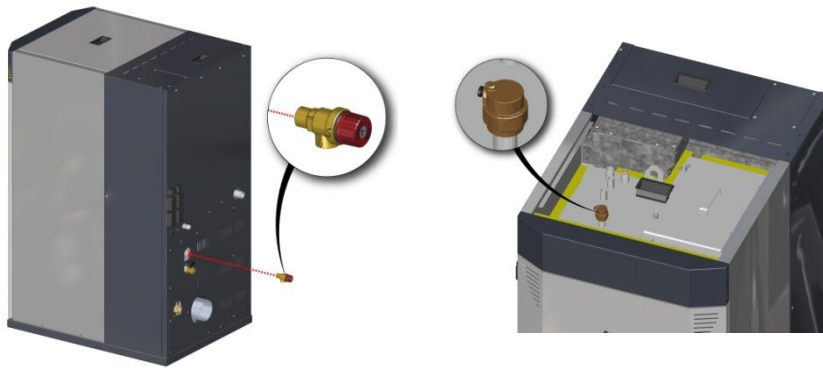

*Picture 7. Assembling safety elements*

### Thermostats in the automation system of the boiler

- In the automation system that runs the combustion process and affects the work of the boiler and cycles of heating, there is one safety thermostat. Safety thermostat functions as a limiter of the temperature of water in the boiler and is limited to 110°C, *picture 8*. In case of overheating, wait until water temperature drops under 60°C and manually reset the button of STB thermostat.

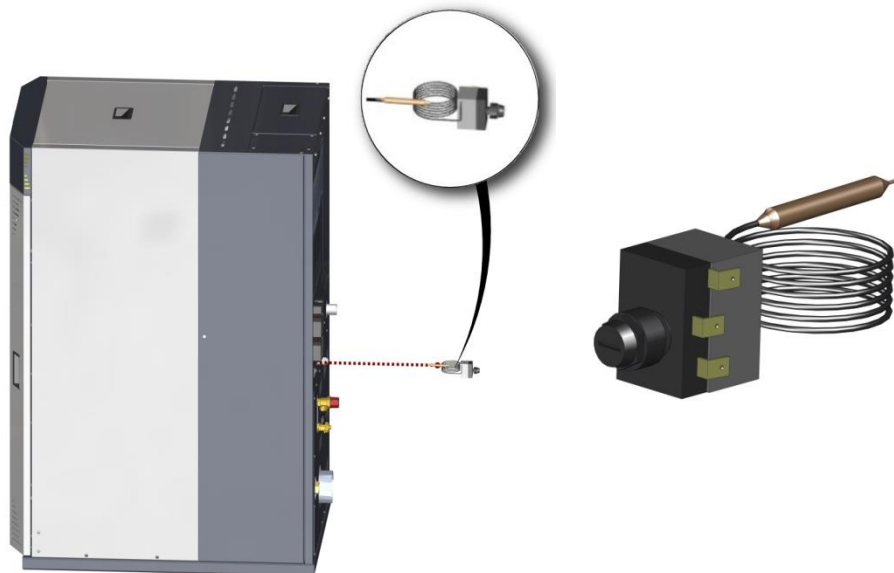

*Picture 8. Safety thermostat in the automation system of the boiler*

- For boiler automation system and cycles of heating, NTC sensors are used which serve for setting the desired temperature. Boiler NTC probe is limited to 95°C.
- In case of reaction by any safety element, the automation system takes over a series of activities, enters the safety operating modality in which the pump must be turned on for the temperature to drop.
- In addition to the stated thermostats, the automation system is also equipped with a contact thermostat for supervision of the pellets temperature in the silo, *picture 9*. In case this thermostat

Radijator Inženjering d.o.o, 36000 Kraljevo, Živojina Lazića - Solunca br.6, Srbija  
 tel. +381 36 399 140, fax. +381 36 399 150, <http://www.radijator.rs>  
 e-mail: [radijator@radijator.rs](mailto:radijator@radijator.rs)

is activated, the automation system takes the following steps: turns off the feeder and turns on the fan, in order to stop the flame.



*Picture 9. Contact thermostat*

### Thermal safety valve (TSV)



*Picture 10. Thermal safety valve*

- This safety element also has a role of temperature limiter. In some extremely dangerous situations, change of water into water vapour is such that pressure safety valves are not sufficient to ensure the safety of hydraulic system. For this reason, it is mandatory to install the thermal safety valve. Depending on the legislation of the country in which the boiler is being assembled, thermal safety valve should be installed only for powers higher than those specified or it should be installed for boiler of any power. Place for installation is shown on the boiler assembly scheme and on *picture 10*. Copper coil is delivered with the boiler, so it is necessary to use the thermal safety valve with exchanger, as in the *picture 10*. Cold sanitary water is supplied to the thermal safety valve. When the probe of the valve receives information that the temperature is over 95°C, the valve opens and water passes through the copper coil. After some time, the temperature of water in the boiler drops to normal. One connection of the coil is used for the thermal safety valve, and the other for draining of water that has passed through the coil. It is irrelevant which connection is for the valve and which for draining. It is mandatory to adhere to the instructions provided by the manufacturer of the thermal safety valve. The function of the thermal safety

Radijator Inženjering d.o.o, 36000 Kraljevo, Živojina Lazića - Solunca br.6, Srbija  
tel. +381 36 399 140, fax. +381 36 399 150, <http://www.radijator.rs>  
e-mail: [radijator@radijator.rs](mailto:radijator@radijator.rs)

valve should be checked up at certain intervals. As it has already been said, one end of the thermal safety valve is to be installed onto the boiler exchanger, while the cold water under pressure is supplied to the other end. It is particularly important that the flow of that water is unobstructed even during power cut.



**If it is not possible to ensure supply of cold sanitary water even during power cut, it is mandatory to connect the boiler to an open system.**

### 3.3 Positioning of the Ecoflame Plus boiler in the boiler room

Boiler room must be secured from freezing.

The support surface for the boiler in the boiler room must be of non-combustible material. Recommended distances of all four sides of the boiler in relation to the boiler walls or other solid body (buffer, etc.) are shown in *picture 11*. These distance values allow a safe access when firing, sufficient space for cleaning and unobstructed access to the fan and valve for filling and drainage. Boiler at its left hand side should be at a distance of 400mm from the wall. The space behind the boiler is important for assembly into the hydraulic system and for potential removing of the system for electric firing. **Boiler room must have sufficient ventilation holes both for fresh air and for the outlet of the exhaust air.**

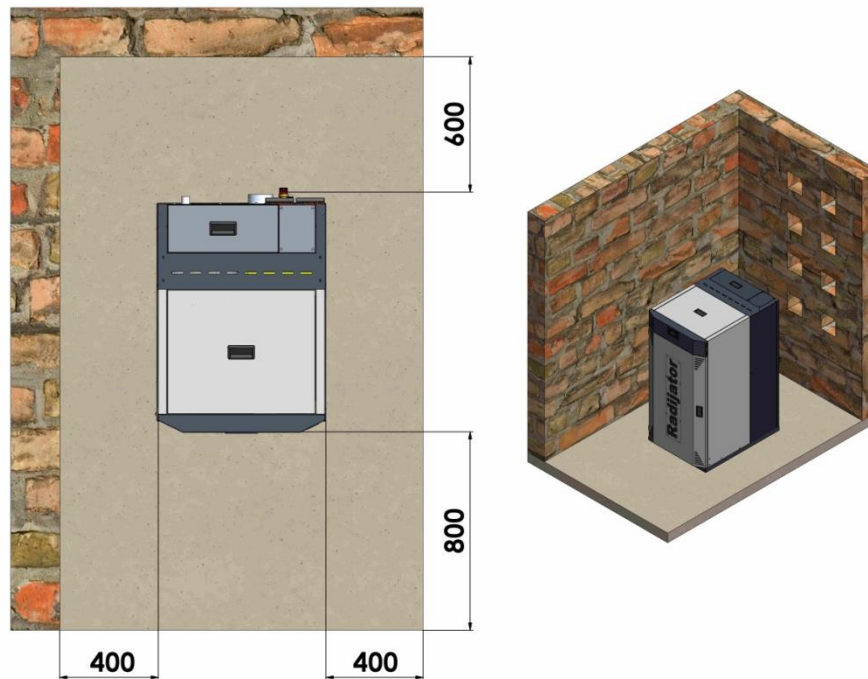

*Picture 11. Positioning of the boiler in the boiler room*

Total area of these openings is minimum 150cm<sup>2</sup> for powers up to 50kW, while for the power over 50kW, the area must be bigger for 2cm<sup>2</sup> per kW.

$$A = 150 \text{ cm}^2 + \frac{2 \text{ cm}^2}{\text{kW}} \cdot (\sum Q_n - 50 \text{ kW}) \quad \sum Q_n = \text{of potential power over 50 kW.}$$

Lack of sufficient ventilation in the boiler room may cause more problems in the work of the boiler. The main problem is the inability to achieve high temperature of output water, i.e. not achieving maximum power, which leads to condensation in the boiler.

- Take into account the required minimum space needed for accessing safety elements and for cleaning and regular repair.
- Determine whether the level of electrical protection is in accordance with the characteristics of the room where the boiler will be located.
- It is forbidden to expose the boiler to harsh weather conditions. The boiler is not designed for outdoor use and does not contain a system against freezing.
- It is forbidden to close the vents in the boiler room. Vents are necessary for proper combustion.

### 3.4 Connection to chimney

During assembly of the chimney, we distinguish two situations:

- **Situation 1:** The boiler is connected to the standard chimney (masonry or metal) that has its own foundation and full cross-section from the foundation to the top.
- **Situation 2:** Boiler is connected to the prefabricated metal chimney attached to the facade.

#### **Situation 1:**

- Ceramic or metal pipes of circular cross-section of minimum 130mm in diameter should be used for chimney. Flue pipe must be insulated.
- If the chimney already exists and is of square cross-section, then the minimum dimension of the intersection is 130x130mm.
- It is not allowed to use the chimney for connecting multiple devices.
- It is not allowed to use air ducts as chimney.
- Top of the chimney should be protected with a chimney cap because of the impact of rain and wind. Distance from the cap to chimney should be 200mm.
- Chimney should come out above the roof as per the recommendations, *picture 12*. If there are some tall objects near the chimney, this should also be taken into account and the height of the chimney additionally increased.
- The chimney must also have a connection for extracting condensation, as well as a revision door. During operation, the door should always be well sealed.

#### **Situation 2:**

- In this situation, the flue pipe must go minimum 1.5m vertically upwards in the very room in which the boiler is located, then to penetrate through the wall and be connected to chimney.
- Flue pipe must have a T piece for condensation at the very outlet from the boiler, as well as the possibility to be removed for cleaning.

**WARNING:** Not adhering to the rules during installation of the flue pipes and chimney may result in improper work of the boiler, but may also endanger human health and even their lives. The greatest threat comes from the toxic gases which are a product of combustion. In such situation where the flue pipes, chimney and inflow of combustion air have not been assembled in a way prescribed by the instruction manual, Radijator Engineering does not have a liability for any undesired consequences.

1. Vessel for condense
2. T piece
3. Flue pipe
4. Elbow - segment M-F 90
5. Rosette F-F
6. Rosette M-F
7. Elbow - segment M- F 90
8. Wall bracket
9. Cap

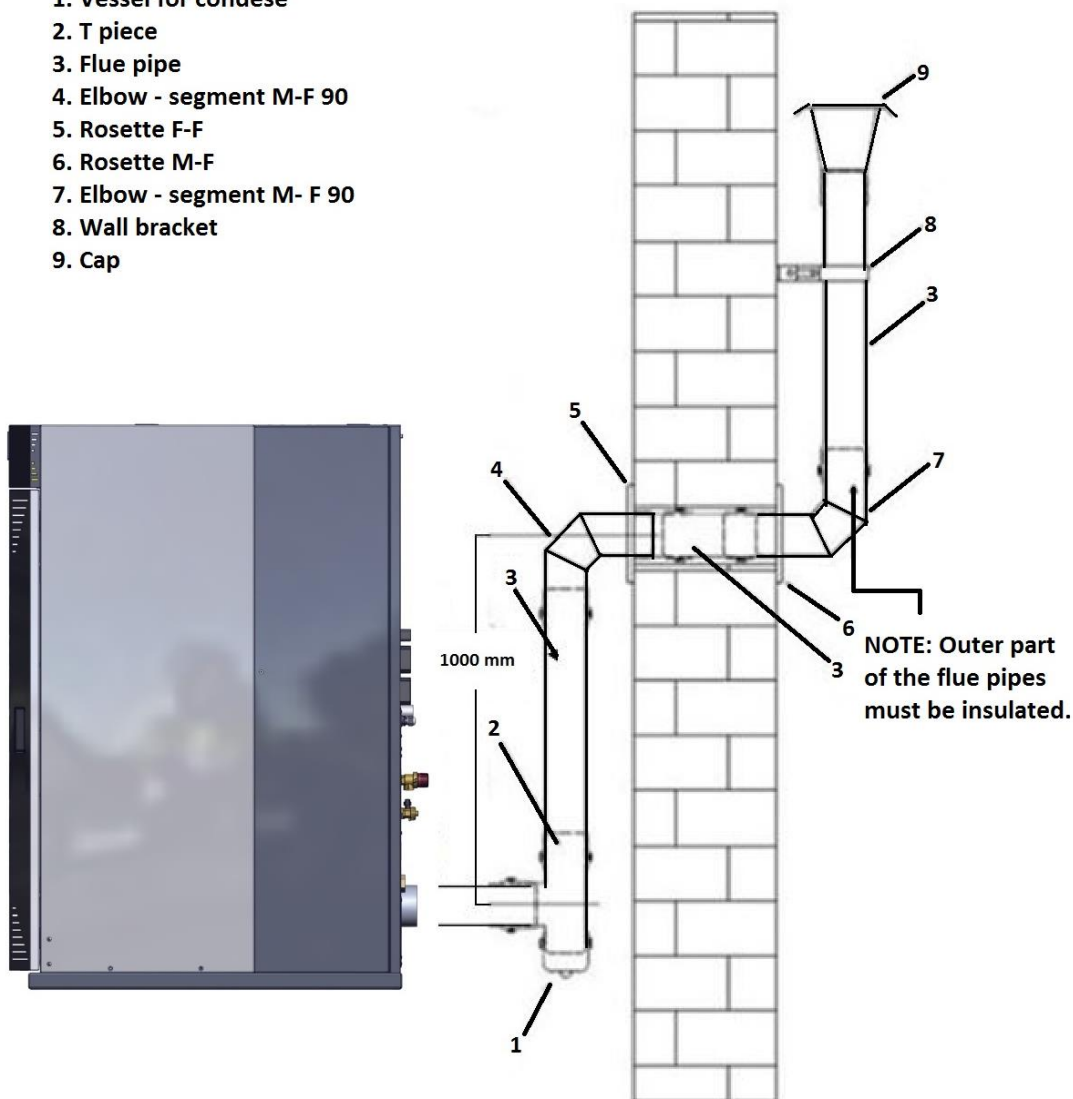

*Picture 12. Installation of flue gas channels*

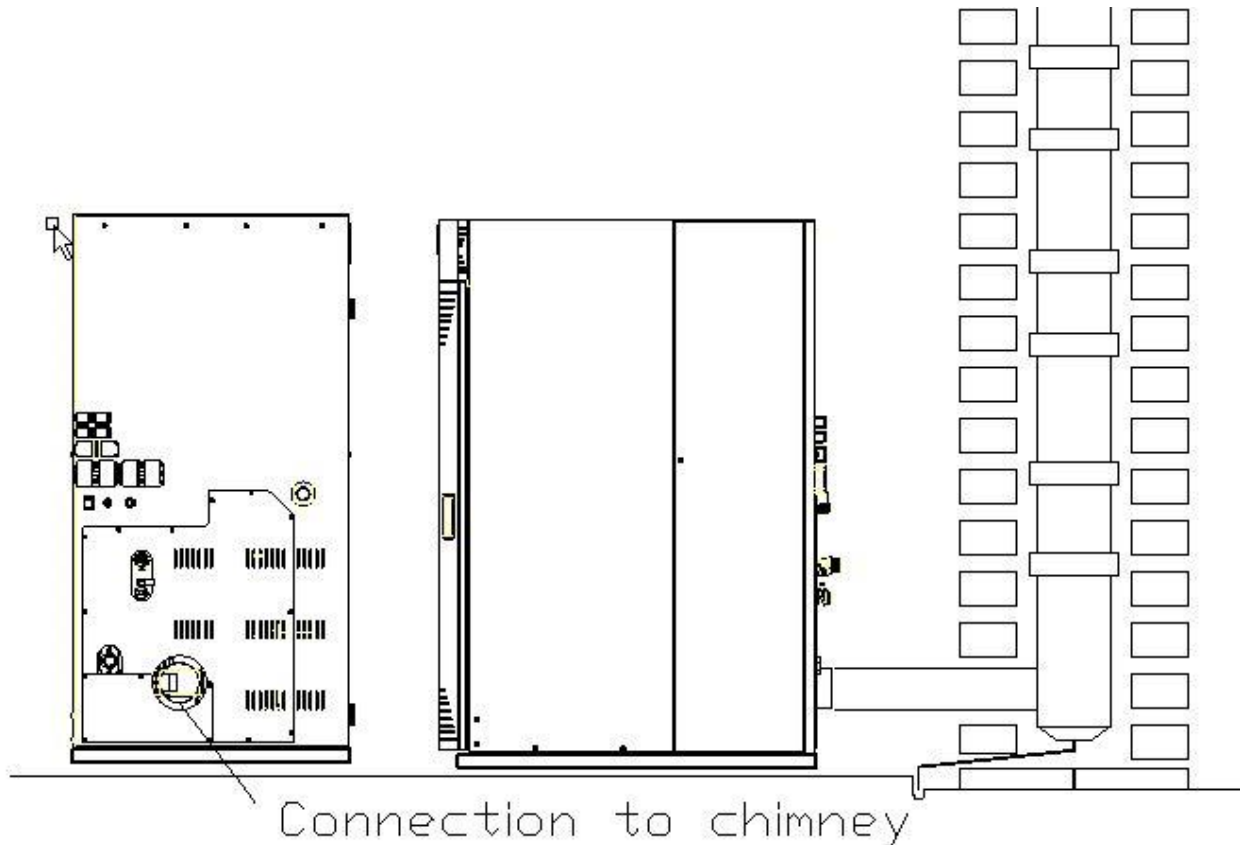

*Picture 13 . Connection to chimney*

If possible, arches should be avoided. If not possible, then maximum number of arches should be 2. It is desirable to insulate flue gas channel from the boiler to chimney, especially if there are arches and longer sections. Flue gas probe is factory-installed in the housing of the exhaust gas fan. Prior to commissioning of the boiler, check whether the probe is still located in its place after the transport, since without adequately installed probe the boiler will not operate.

The chimney should be made of ceramic pipes, and around them there should be insulation of 3-5cm, while the back outer layer should consist of bricks or special elements. If the chimney is not, however, made of ceramic but of bricks, the light opening area of such chimney must be 30 % higher than the same area of ceramic chimney.

The chimney must have a door for cleaning and the door must be well sealed. Chimney outlet on the roof must be made in accordance with certain regulations. There are two different cases: if the roof angle is smaller than 12° and if it is bigger than 12°. For the angle smaller than 12°, the height of the chimney above the roof is 1m, while for the angle bigger than 12° please take a look at the *picture 14*.

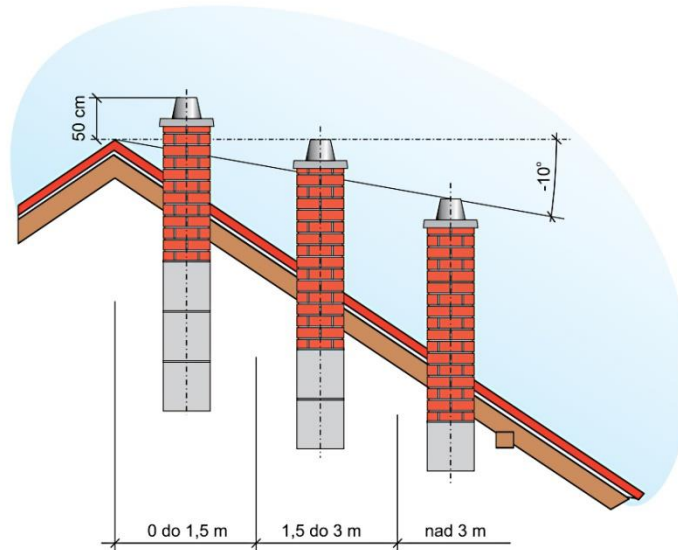

*Picture 14. Recommendation when building the chimney*

If you think that the chimney is too strong and that too much cold air passes through the boiler, at the exit of the boiler, there is a valve which can reduce the flow of exhaust gases. The chimney should be cleaned regularly or at least once a year.



*If the chimney is not of the prescribed height, cross-section or if it is not cleaned, there could be complications in the operation of the boiler. Primarily, high-temperature operating mode is not possible, that is, there is no maximum working power, resulting in appearance of condensation that affects boiler life expectancy.*



*Weak chimney is the main reason for smoke appearing on the upper or lower door during the ignition of the boiler or during the operation, especially at higher fan speeds.*



## 4. Connection scheme of automation system

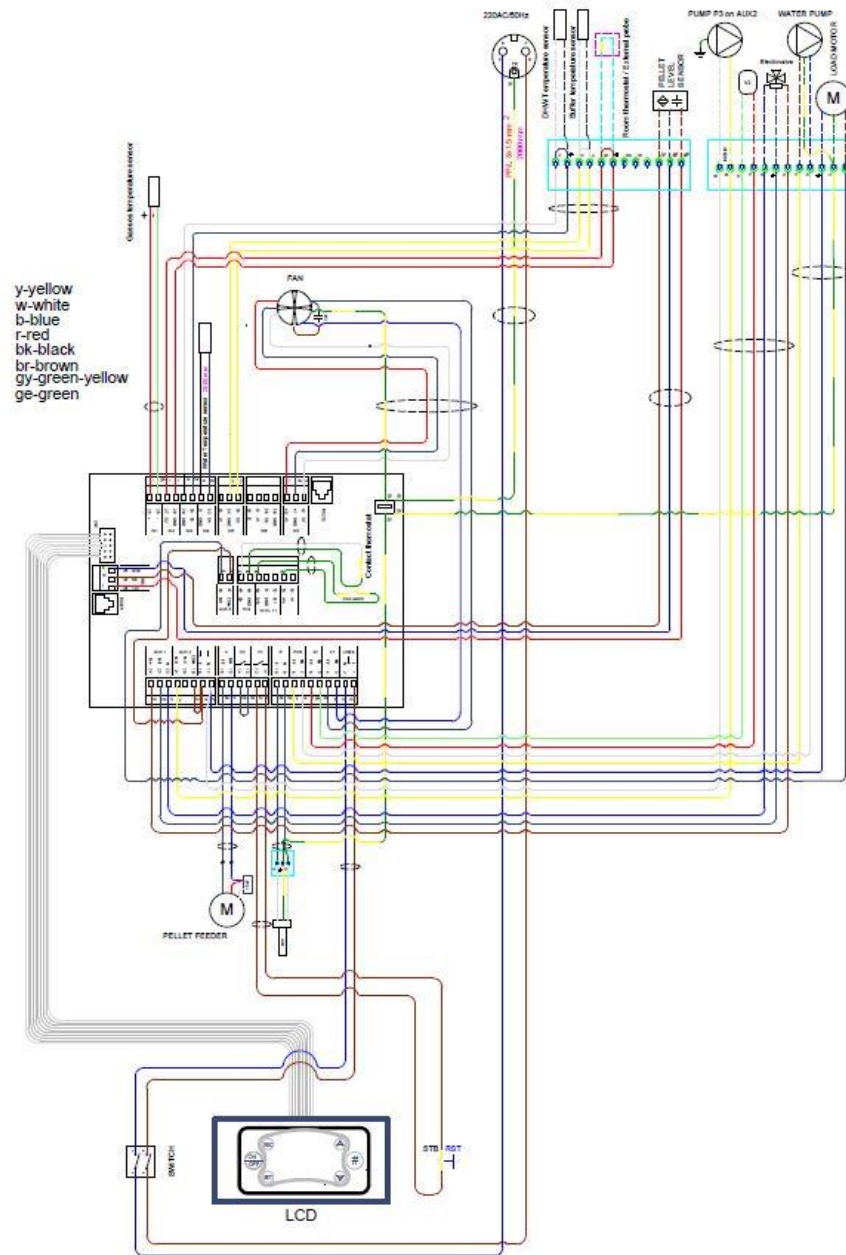

Picture 15. Connection scheme of automation system



**For the room thermostats, it is important that they are battery-powered, i.e. that they do not have any supply of 220V. NC (normally closed contact) is used for connection on the thermostat itself.**



**The boiler may operate even if the central heating pump has not been connected, but the manufacturer recommends that it be installed because it has a function of a safety element. It turns on when the temperature of water in the boiler exceeds 90°C.**

## 5. Technical data table

Type of boiler		<b>Ecoflame 25</b>	<b>Ecoflame 30</b>
<b>CE designation</b>		CE	CE
<b>Boiler class as per EN 303-5:2012</b>		5	5
<b>Working pressure</b>	<i>bar</i>	2	2
<b>Test pressure</b>	<i>bar</i>	4,5	4,5
<b>Volume of water in the boiler</b>	<i>L</i>	81	81
<b>Boiler weight</b>	<i>kg</i>	375	375
<b>Minimum cross-section of the chimney</b>	<i>mm</i>	130	130
<b>Necessary draft of the chimney</b>	<i>mbar / Pa</i>	0,12/12	0,12/12
<b>Boiler temperature (min / max)</b>	<i>°C</i>	60-90	60-90
<b>Minimum temperature of the cold water connection</b>	<i>°C</i>	60	60
<b>Efficiency degree at nominal/minimal thermal power</b>	<i>%</i>	92,35/92,82	91,98/92,53
<b>Nominal power</b>	<i>kW</i>	25,27	29,97
<b>Minimum/maximum power of boiler</b>	<i>kW</i>	8,5/25,27	11/29,97
<b>Carbon monoxide (CO) emission at minimal thermal power (10% O<sub>2</sub>)</b>	<i>mg / m<sup>3</sup></i>	366,3	360,3
<b>Carbon monoxide (CO) emission at nominal thermal power (10% O<sub>2</sub>)</b>	<i>mg / m<sup>3</sup></i>	131,85	124,63
<b>Dust at nominal/minimal thermal power (10% O<sub>2</sub>)</b>	<i>mg / Nm<sup>3</sup></i>	13,37/23,32	12,65/22,32
<b><i>Dimensions</i></b>			
	<i>A</i>	690	690
	<i>B</i>	1355	1355
	<i>C</i>	935	935
	<i>C1</i>	1000	1000
	<i>φD</i>	100	100
<b>Connection for hot water from the boiler</b>	<i>D1</i>	1"	1"
<b>Connection for cold water from the boiler</b>	<i>D2</i>	1"	1"
<b>Filling and drainage connection</b>	<i>D3</i>	1/2"	1/2"
<b>Safety valve connection</b>	<i>D4</i>	1/2"	1/2"
<b>Connection for air vent</b>	<i>D5</i>	1/2"	1/2"
<b>Connection for thermal safety valve (TSV)</b>	<i>D6</i>	1/2"	1/2"
<b>Connections for thermal safety valve probe</b>	<i>D7</i>	1/2"	1/2"

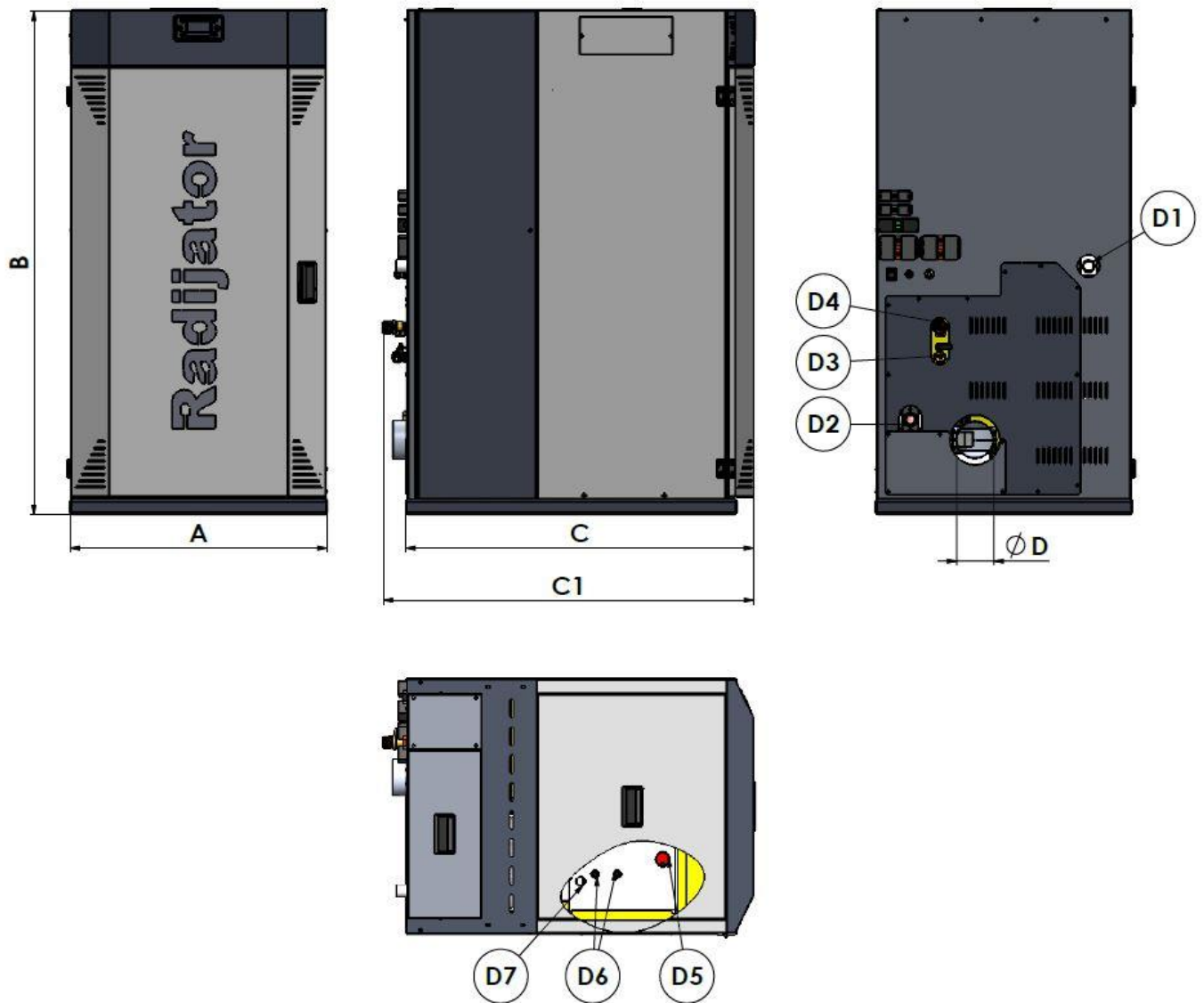

*Picture 16. Projections of boiler with dimensions*

## 6. Hydraulic scheme

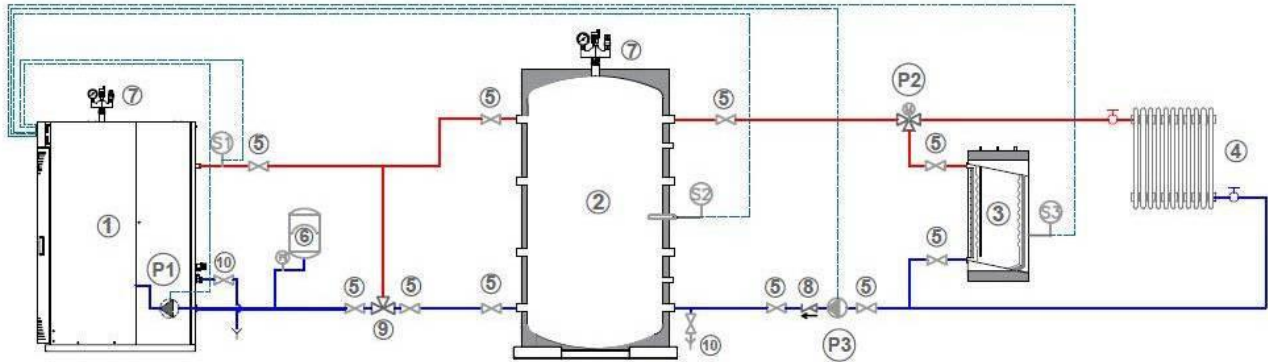



Picture 17. Hydraulic scheme

LEGEND	
1.	Boiler Ecoflame Plus 25kW
2.	Buffer
3.	Sanitary water heater
4.	Exchanger
5.	Ball valve
6.	Closed expansion vessel
7.	Safety group (safety valve, manometer, air vent)
8.	Check valve
9.	Manual three-way valve
10.	Filling and drainage tap
P1	Pump
P2	Three-way motorized zone valve
P3	Pump
S1	Temperature sensor
S2	Buffer temperature sensor
S3	Domestic hot water (DHW) temperature sensor

 **WARNING!**

 During the assembly on hydraulic installation, the boiler must be protected as prescribed against excessive overheating and overpressure.

 Central heating installer who connects the boiler to the hydraulic system is responsible for adequate assembly.

 Radijator Inženjering, as the manufacturer of the boiler, shall have no liability for damages caused by inadequate boiler installation.

Radijator Inženjering d.o.o, 36000 Kraljevo, Živojina Lazića - Solunca br.6, Srbija  
 tel. +381 36 399 140, fax. +381 36 399 150, <http://www.radijator.rs>  
 e-mail: [radijator@radijator.rs](mailto:radijator@radijator.rs)

## 7. Boiler start-up and maintenance



***The first commissioning of the boiler should be performed by a technician certified by Radijator Inženjering. Training the boiler user is mandatory.***

*In this way, this person is authorized to notify the customer service in the factory about the time when the boiler started its operation and the condition of the boiler at its first firing, while keeping a copy of the report on the commissioning of the boiler. Warranty and instruction manual are given to the customer. One copy of the warranty is sent to the manufacturer.*

*If the warranty has not been filled in, it is not valid.*

*Only the boilers commissioned by the authorised technician are subject to the warranty conditions.*

*The following text is intended for the user of the boiler, as a reminder, to be able to start up the boiler on their own, should they turn off the boiler (e.g. for cleaning).*



*Parameters related to the boiler operation, which are available to the user, are on the display.*

*The remaining parameters which are found in the so-called hidden menu should not be changed without the consent of the technician who commissioned the boiler or the factory itself.*

### 7.1 LCD 100 display

#### 7.1.1 Introduction

The main screen shows:

- 1 Combustion power;
- 2 Combustion recipe;
- 3 Current temperature of water in the boiler;
- 4 Set temperature of water in the boiler;
- 5 Status or error in the work of the system;
- 6 Functional state of the boiler;
- 7 Date and time;
- 8 Chrono is activated.

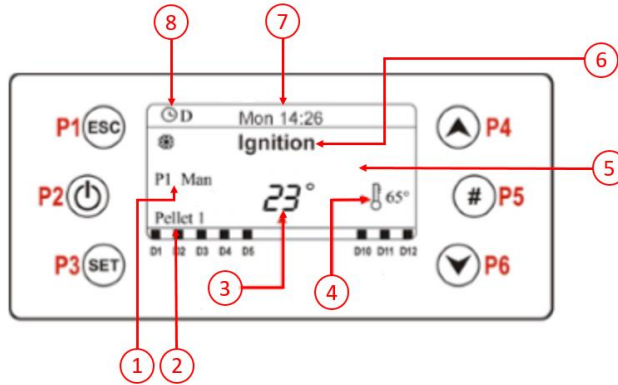

Picture 18. LCD 100 Display

Button	Function
P1	Exit menu and submenu;
P2	Ignition and extinguishing (push for 3 seconds), Reset error (push for 3 seconds), Enable/disable chrono;
P3	Enter in User Menu 1/submenu, Enter in User Menu 2 (push for 3 seconds), Save data
P4	Enter in Visualizations Menu, Increase
P5	Enable chrono program
P6	Enter in Visualizations Menu, Decrease
Led	Functions
D1	Heating Resistance On
D2	Auger On
D3	Pump On;
D4*	Valve On;
D5	Output V2 On
D6*	Pump 3 active.;
D7*	Engine on auxiliary silo active;
D8	
D9**	External Chrono Reached
D10*	Pellet Sensor signalling lack of material;
D11*	Room thermostat reached;
D12*	Domestic Hot Water (DHW) demand
* It is necessary to install additional equipment that is not found in the scope of delivery of the basic version. For all information, please contact the authorised service technician.	

Automation system has a possibility to diagnose obstructions and problems in operation. Automation system signals any abnormal state via a message on the screen and by undertaking adequate action. The messages shown on the screen are divided into two groups:

Radijator Inženjering d.o.o, 36000 Kraljevo, Živojina Lazića - Solunca br.6, Srbija  
tel. +381 36 399 140, fax. +381 36 399 150, <http://www.radijator.rs>  
e-mail: [radijator@radijator.rs](mailto:radijator@radijator.rs)

- Errors and
- Other messages.

### 7.1.2 Errors

Errors are messages that signal a problem in the operation of the system. They are characterized by Err mark and the system will go to extinguish modality and then to blockade. That means that the system is blocked and starting up the system again is disabled until the problem has been removed.

Er01	Safety thermostat signalling. Temperature of water in the boiler is too high. System signals the error even when it's off.
Er02	Safety thermostat signalling. Temperature of water in the boiler is too high. System signals the error only when the boiler is operating.
Er03	Flue gases temperature is too low.
Er04	Temperature of water in the boiler is too high.
Er05	Flue gases temperature is too high.
Er07	Encoder Error. The error may occur due to lack signal Encoder.
Er08	Encoder Error. The error can occur due to problems of adjustment of the number of Revolutions.
Er11	Clock Error. The error occurs due to problems with the internal clock.
Er12	Extinguishing for ignition failure.
Er15	Extinguishing due to power failure.
Er16	RS485 communication error
Er18*	System shutting down due to exhaustion of pellet.
Er23	Boiler probe or Back boiler probe or probe Buffer open.
Er56	Problem with configuration of water distribution, more in the section Heating Management.
In case of errors not defined in this table, contact the service technician. Errors marked with * refer to additional equipment, which is not included in the delivery of the basic version.	

### 7.1.3 Other messages

Sond	Displaying the status of the Temperature Sensors. The message is displayed during the check-up and indicates that the temperature reading on one or more probes is equal to the minimum value or the maximum value (depending on the probe considered). The message is displayed in the ignition phase. It is recommended to check the connection of probe to the automation system.
Service	Message that signals the achievement of scheduled operating hours. It's necessary to call a service technician for regular service.
Clean	Message that signals the achievement of scheduled operating hours. It's necessary to clean the boiler.
Port	Boiler door is open.
Link error	Lack of communication between keyboard and control board.
Cleaning on	The system is performing its own/automatically scheduled Periodic Cleaning.

Ignition Block	Message that appears if you try to turn off the system in the ignition phase. The system will turn off only after it has entered the Run mode.
Er06	Thermostat Pellet open.
Er20	In the basic configuration, appearance of this error has not been envisaged. In case it appears, call the certified service technician.

### 7.1.4 Monitoring

In order to access the screen for monitoring, press the button P4 ili P6:

<b>Exhaust T.</b>	Exhaust temperature [°C]
<b>Boiler T.</b>	Boiler temperature [°C]
<b>Boiler Return T.*</b>	Boiler return temperature [°C]
<b>Buffer T</b>	Buffer temperature [°C]
<b>DHW T.</b>	Domestic hot water temperature [°C]
<b>Fan Speed</b>	Combustion Fan speed [rpm]
<b>Auger</b>	Auger work time [s]
<b>Product Code 549</b>	Product Code
*This value is not available in the standard scope of delivery.	

#### User Menu 1

In order to access this menu, press button P3.



<b>Combustion Management</b>	<b>Pellet power</b> This Menu allows to set the system's combustion in automatic or manual mode. If the manual mode is set, the user must also choose the combustion power.						
	<b>Auger Calibration</b> Menu to change the Auger's work time or speed. The system has 10 calibration steps (0 value is set by the factory). The calibration effect is valid only in Run Mode and Modulation. For each step the value is increased in percentage for the value P15.  Example: <b>P15</b> =10%, Step= -1						
	<b>Default values</b>	C03=2,0	C04=3,0	C05=4,0	C06=5,0	C07=6,0	C11=1,0
	<b>Calibrated values</b>	C03=1,8	C04=2,7	C05=3,6	C06=4,5	C07=5,4	C11=0,9

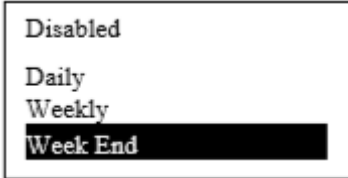
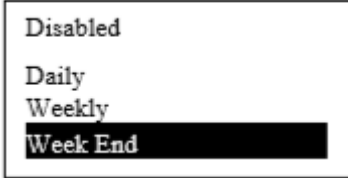

<b>Fan Calibration</b> Menu to change the Combustion Fan speed. The system has 10 calibration's steps (the 0 value is set by the factory). The calibration's effect is valid only in Run Mode and Modulation for the current recipe. For each step the value is increased in percentage for the value P16.  Example: <b>P16=5%</b> , Step= +3						
<b>Default values</b>	U03=1000	U04=1200	U05=1400	U06=1600	U07=1800	U11=900
<b>Calibrated values</b>	U03=1150	U04=1380	U05=1610	U06=1840	U07=2070	U11=1030

<b>Heating Management</b>	<b>Boiler Thermostat</b> Menu which allows to modify the Boiler Thermostat's value. *If it is possible to manage the outdoor temperature sensor, this menu is not available because water temperature is automatically calculated.
	<b>Buffer Thermostat*</b> Menu which allows to modify the Buffer/Top Buffer Thermostat's value.
	<i>Bottom Buffer Thermostat**</i> Menu which allows to modify the Bottom Buffer Thermostat's value.
	<b>DHW Thermostat*</b> Menu which allows to modify the Domestic Hot Water thermostat value.
	<i>Flow Thermostat*</i> Menu which allows to modify the Flow thermostat's value in configuration 9.
	<i>Room Thermostat*</i> Menu which allows to modify the Room Thermostat's value in the boiler room.
	<b>Summer-Winter</b> Summer or winter operating modality of the boiler.
	<b>Climatic Function* (Outdoor temperature sensor)</b> Menu to manage the climatic function, i.e. to modify outdoor temperature sensor. Menu has two submenus, Enable and Comfort Function. Enable: allows the user to enable/disable the outdoor temperature sensor. Comfort Function: allows to correct the calculated thermostat by $\pm 20$ °C. Outdoor temperature sensor works only in Winter mode. If the function is enabled, the symbol  is shown on the display.
<b>Mixer Valve*</b> Menu to manage the Mixer Valve. It is possible to regulate it in automatic mode or force it to open or close.	
*Appearance of these values on the display depends on the configuration in which the boiler works. For more information, address a professional.	

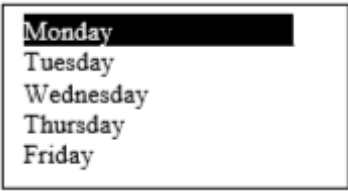
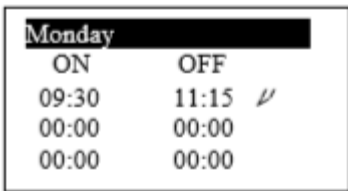
Load*	This menu allows loading manually the Auger. The system has to be in Off state to do the loading.	
Cleaning Reset*	This menu allows to reset the message Clean.	
Chrono	Menu that enables the Chrono operating mode. Chrono is the mode that enables ignition/extinguishing of the boiler as per the already defined operating mode.	
	<p><b>Modality</b></p> <p>It allows selecting the desired operating modality of the Chrono mode or disable the Chrono mode.</p> <ul style="list-style-type: none"> <li>• Enter modification mode by pressing button P3.</li> <li>• select the chosen modality (Daily, Weekly or Week End) by moving up or down (button P4 or P5).</li> <li>• Enable/disable Chrono mode by pressing P2.</li> </ul> <p>Save the settings by pressing P3.</p>	
	<p><b>Programming</b></p> <p>The system enables three types of programming:</p> <ul style="list-style-type: none"> <li>• Daily,</li> <li>• Weekly,</li> <li>• Week End.</li> </ul> <p>After selecting the desired type of programming:</p> <ul style="list-style-type: none"> <li>• Choose a day in the week or a period that you would like to programme by pressing keys P4 or P6.</li> <li>• When you choose the period, enter submenu by pressing the key P3.</li> <li>• Change the time via keys P4 and P6.</li> <li>• Enable (a “V” is displayed) the time interval by pressing key P5. Disable the time interval (a “V” is not displayed”) by pressing the keys P5.</li> </ul>	

	<p><b>Programming the interval to include the next day:</b></p> <ul style="list-style-type: none"> <li>• Example: We want the boiler to turn on on Tuesday at 22:30h, and to turn off on Wednesday at 06:30h.</li> <li>• Set the boiler to turn on on Tuesday at 22:30h.</li> <li>• Set the boiler to turn off on Tuesday at 23:59h.</li> <li>• Set the boiler to turn on on Wednesday at 00:00h.</li> <li>• Set the boiler to turn off on Wednesday at 6:30h.</li> <li>• The system will turn on on Tuesday at 22:30h, and turn off on Wednesday at 06:30h.</li> </ul>	
	<p><b>Daily</b> Select a day in the week and set the time when the boiler will turn on or turn off.</p>	
	<p><b>Weekly</b> Programme is the same for all days of the week.</p>	
	<p><b>Week-end</b> You may programme the intervals for work days (choose between 'Monday-Friday') and for the week end (chosed 'Saturday-Sunday').</p>	

*User Menu 2*

To enter the menu press and hold **P3**.

<b>Keyboard Settings</b>	<p><b>Time and date</b> Used to set the day, month, year and current time.</p>
	<p><b>Language</b> Menu to modify the keyboard language.</p>

<b>Display menu</b>	<b>Brightness</b> Menu used to regulate the display brightness.
	<b>Minimum Light</b> Menu used to regulate the lighting of the display when the display is not used.
	<b>Sound</b> It allows to enable or disable the acoustic alarm of the keyboard.
	<b>Keyboard Address</b> This menu is password-protected and no changes should be made in it.
	<b>Node list</b> This menu shows communication address, FW code, FW version, etc. Data are not modifiable.
<b>System menu</b>	A password is needed for entering the menu. Settings in the System menu are intended for professionals.

## 7.2. Functioning states of the system

- Off – The system is off;
- Check Up – check-up whether everything is fine with the system and whether the ignition may safely start;
- Ignition;
- Stabilization - Operating modality between Ignition and Run mode. Its role is to ensure the stable work of the boiler in the working mode.
- Recovery Ignition – The operating mode is activated during ignition only if the system had not been regularly turned off for some reason (cable unplugged, longer power cuts, etc.);
- Run mode – Normal operating modality, the boiler has still not reached the set temperature;
- Modulation – Normal operating modality, the boiler has reached the set temperature;
- Standby – Boiler is in the standby modality, ready to start. It is usually used in combination with room thermostat.
- Safety – safety operating modality. The boiler enters this modality only if the flue gases temperature or water temperature are too high;
- Extinguishing – Boiler is turning off;
- Block – Automation system has detected irregularities in the work of the system.

## 7.3. Door sensor

- Sensor on the boiler door is a standard part of the boiler equipment. The sensor detects whether the door of the boiler is open and sends a signal to the automation system. In case you open the door while the boiler is working, the automation system of the boiler will do the following:
  - o Stop the system for feeding pellets;
  - o Fan speed will be at its maximum;
  - o The message port/door will appear on the display.
- After shutting the door, the boiler will continue its normal work.
- Automation system displays a message port/door even in the OFF mode (i.e. when the boiler is turned off).

These precaution measures prevent the return of the flame through the boiler door and guarantee safety to the user.

## 7.4. Pellet thermostat

- Pellet thermostat is also a standard part of the boiler equipment. In case the temperature of the pellets reaches a critical value, the automation system will do the following:
  - o Stop the system for feeding pellets;
  - o Fan must remain turned on;
  - o Turn of the heating element (if it was turned on);
  - o Write a message Er06 on the display.

These precaution measures increase the safety level of the system.

## 7.5. Installing additional equipment

### 7.5.1. Introductory notes

Settings and connecting additional equipment may be performed only by professionals.

The number of inputs and outputs in the automation system is limited. When choosing additional equipment, consider your priorities carefully with a professional. Not all additional equipment can be installed at the same time. Make priorities. You have available three temperature inputs, input for the sensor of pellets level, two outputs that may be used for different purposes (their behaviour is programmed by parameters), output for electro valve and output for boiler pump.

Each output of the automation system has uniformly defined maximum permanent current load.

Maximum one-time permanent current load of the automation system is 6.3A. Maximum load per output is 3A. Factory-installed power is 420W, or 1.8A.

Installer of additional equipment is due to take care of limitations of individual outputs, as well as of maximum on-time load of the automation system.

In the following situations:

- o Maximum one-time load exceeds 6.3A;
- o Individual output is overloaded;
- o You need a three-phase consumer unit;

Our recommendation is to use relays and contactors of adequate characteristics.

### 7.5.2. Room thermostat or outdoor temperature sensor

It is not possible to install the room thermostat and outdoor temperature sensor at the same time.

#### 7.5.2.1 Room thermostat

Input for room thermostat is dry contact. For the room thermostat it is important to be battery-powered on, i.e. they should not have any supply of the voltage of 230V. On the thermostat for the connection NC is used (normally closed contact).

Connecting: remove the jumper in the connector and connect the thermostat as per the connection diagram.

### 7.5.2.2 Outdoor temperature sensor

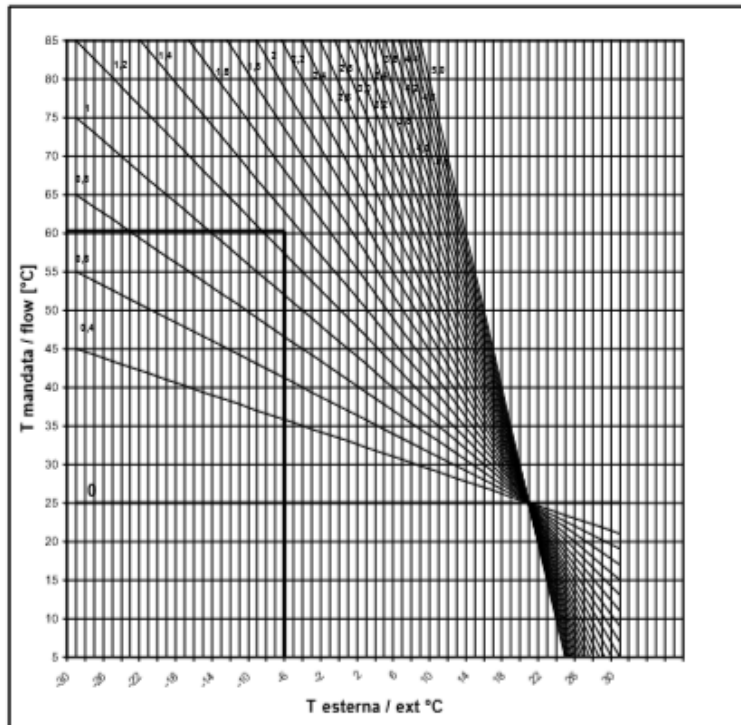

**Picture 19. Outdoor temperature sensor**

Outdoor temperature sensor cannot be installed in the configuration 10.0.

Outdoor temperature sensor can be installed with configurations 10.1; 10.2 i 10.3.

Outdoor temperature sensor cannot be installed together with the room thermostat.

#### **WORK PRINCIPLE:**

##### **Systems without buffer**

Temperature in the boiler is calculated automatically and varies in the range from Th26 to Th27. Calculation is done on the basis of a linear curve. The selection of curve is done by setting parameter P60. Our recommendation for parameter P60=1.

##### **Systems with buffer**

Buffer temperature is automatically calculated as per the system described above, while the temperature of water in the boiler is calculated as a sum of buffer temperature and parameter D11. The selection of a linear curve is done by setting parameter P60. Our recommendation for parameter P60=1.

##### **Outdoor temperature sensor and configuration 10.1**

Change of parameters:

P74 [configuration of the outdoor temperature sensor] = 7

P26 [confirmation of configuration] = 0

##### **Outdoor temperature sensor and configuration 10.2**

Change of parameters:

P74 [configuration of the outdoor temperature sensor] = 7

P26 [confirmation of configuration] = 2

### ***Outdoor temperature sensor and configuration 10.3***

Change of parameters:

P74 [configuration of the outdoor temperature sensor] = 7

P26 [confirmation of configuration] = 4

### ***Connecting***

Outdoor temperature sensor should be connected to the output Room thermostat as shown in the connection scheme.

### **7.5.3. Start of an alternative/additional source of heat**

If you wish to have an alternative source of heat (e.g. gas or electro boiler), the automation system may manage (ignite and extinguish) the alternative source of heat.

**Work principle:** The output is managed by Th56 Thermostat: above this value is supplied.

**Connection scheme and parameters:** For this function it is possible to use the output V2. The output is of 230V.

Parameters: in System menu, submenu Enables, the parameter P44 is factory-set on value 3.

Then in the System menu, Thermostats submenu, set the parameter Th56 and hysteresis Ih56. Our recommendation is that the parameter Th56 is nearly equal to parameter Th35, and the parameter Ih56 is between 2 and 10°C.

### **7.5.4. Additional system for feeding pellets**

It is necessary to connect the pellet level sensor and the system engine as shown in the scheme.

**Work principle:** When the pellet level sensor signals the absence of pellet, the output is activated which moves the engine for loading of the silo. If in a time T24 signal of the pellet level sensor is still active, the automation system goes in Extinguishing and the display shows the message Er18.

T23 is the time during which the silo is loaded after the signal of the sensor.

Set the following parameters in the System menu:

Enable: P71=2

Timers: T23 and T24 (our recommendation for the parameters is the following - T23=1900; T24=1800).

## **7.6. Heating management**

### **7.6.1 Introductory notes**

Inputs for temperature sensors in the automation system are adjusted to probes NTC 10K. Configuration 10.0 is implied and factory-set. Configurations 10.1, 10.2, 10.3 are automatically generated from the

configuration 10.0 and it is not necessary to do parametrization. Parameters are stated and intended exclusively for professionals.

#### Error Er56

When changing the configuration, Er56 may appear.

In that case, you should do the following:

1. Check the parameters;
2. Turn off the boiler: OFF state;
3. Turn off the power;
4. Check the wiring;
5. Turn on the power;
6. Check in monitoring whether read-outs of probes are in order;
7. Repeat the procedure if necessary.

#### 7.6.2 Configuration 10.0

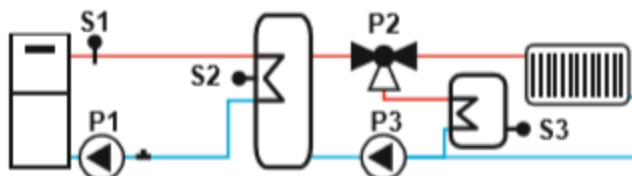

Picture 20. Configuration 10.0

If you want the configuration as shown in the picture, first set the parameter P26=10.

#### Work principle

##### *Anti-freeze protection*

To avoid the freezing of water, if the temperature drops below the previously defined value (Th18), pumps P1 and P3 are activated, and the valve P2 alternately changes the position.

##### *Run mode*

The system heats buffer water if the temperature of water in the boiler is higher than the thermostat value Th19 and if the difference between the temperature of water in the boiler and buffer water temperature is higher than Th57.

The system heats the water in the sanitary water heater if the temperature in the sanitary water heater is lower than Th79 and if the difference between the buffer water temperature and the temperature of water in the sanitary water heater is higher than Th81.

When the water in the sanitary water heater has been heated (Th79), if the room temperature (provided the room thermostat has been installed) has not been reached and if the buffer water temperature is higher than the set temperature (Th59), the system enables home heating.

##### *Over temperature (Overheating of the system – safety function)*

If the water temperature is higher than the previously defined value (Th21 or Th25), pump P1 is activated for safety reasons. If the buffer water temperature is higher than the previously defined value (Th78),



pump P3 is activated and the valve opens the sanitary plant. If the water temperature is higher than Th80, the P2 valve opens the plant.

Recommended values of parameters: **Th18**=5°C, **Th19**=40°C, **Th21**=75°C, **Th58**=60°C, **Th78**=70°C, **Th79**=55°C, **Th80**=65°C, **Th81**=5°C, **Th59**=50°C

<i>Anti-freeze protection</i>							
Probe S1	Probe S2	Probe S3	Diff. 1-2	Diff. 2-3	Pump P3	Pump P1	Electro valve P2
T<5°C	-	-	-	-	ON	ON	Heat. (OFF)
<i>Run mode</i>							
Probe S1	Probe S2	Probe S3	Diff. 1-2	Diff. 2-3	Pump P3	Pump P1	Electro valve P2
T<40°C	-	-	-	-	OFF	OFF	Heat. (OFF)
T≥40°C	-	-	>5°C	≤5°C	OFF	ON	Heat. (OFF)
T≥40°C		T<55°C	>5°C	>5°C	ON	ON	DHW (ON)
T≥40°C	T<50°C	T≥55°C	>5°C	-	OFF	ON	Heat. (OFF)
T≥40°C	T≥50°C	T≥55°C	>5°C	-	ON	ON	Heat. (OFF)
<i>Over temperature (Overheating of the system – safety function)</i>							
Probe S1	Probe S2	Probe S3	Diff. 1-2	Diff. 2-3	Pump P3	Pump P1	Electro valve P2
T≥75°C	T<70°C	T<65°C	-	-	OFF	ON	DHW (ON)
T<75°C	T≥70°C	T<65°C	-	-	ON	OFF	DHW (ON)
T<75°C	T<70°C	T≥65°C	-	-	ON	OFF	Heat. (OFF)
T≥75°C	T≥70°C	T≥65°C	-	-	ON	ON	Heat. (OFF)

By short connection of temperature probes inputs from Configuration 10, another three simplified water distribution systems may be obtained.

#### Wiring:

Connect the DHW Temperature sensor to the connector as shown in the scheme.

Connect the Buffer temperature sensor to the connector as shown in the scheme.

Connect the P3 pump to the connector as shown in the scheme.

Connect the Electro valve to the connector as shown in the scheme.

#### Parameters:

*They are factory-set.*

The following parameters are found in the System menu, submenu Enables:

P26 [selection of configuration] =10;

P75 [DHW Temperature sensor] =8;

P76 [Buffer temperature sensor] =9;

P36 [pump configuration] =14

Parameters **Th18**, **Th19**, **Th21**, **Th58**, **Th78**, **Th79**, **Th80**, **Th81**, **Th59** are found in the System menu → Thermostats menu and should be adjusted to the needs of the user and the instruction above.

### 7.6.3 Configuration 10.1

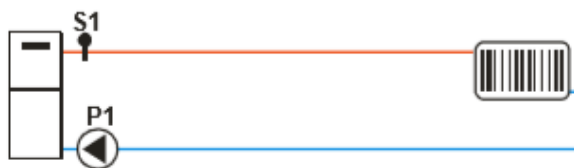

Picture 21. Configuration 10.1

Work principle:

Recommended values of parameters:

**Th18**=5°C; **Th19**=40°C; **Th21**=70°C

Heating plant

The pump is active if the boiler water temperature is above the previously defined value **Th19**. In order to avoid freezing, the pump is on even when the water temperature is below **Th18**. If the water temperature exceeds value **Th21**, the pump is activated for safety reasons.

Wiring:

Connect the output for DHW Temperature sensor to the connector.

Connect the output for Buffer temperature sensor to the connector.

Parameters:

*They are factory-set.*

The following parameters are found in the System menu, submenu Enables:

P26 [selection of configuration] =10;

P75 [DHW Temperature sensor] =8;

P76 [Buffer temperature sensor] =9;

P36 [pump configuration] =14

Parameters **Th18**, **Th19**, **Th21** are found in the **system menu** → **Thermostats menu** and should be adjusted to the needs of the user and the instruction above.

### 7.6.4 Configuration 10.2

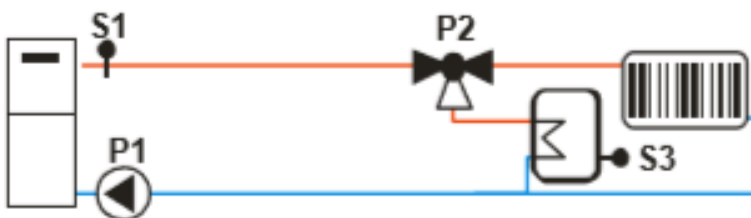

Picture 22. Configuration 10.1

Work principle:

*Heating plant*

Pump P1 is on if the temperature of water in the boiler exceeds the value Th20 of the thermostat, and the buffer water temperature does not exceed the previously defined value Th79 and the difference between the read temperature by probe S1 and S3 probes is greater than the Th57 thermostat. The pump is on if the water temperature in the boiler is higher than Th19 thermostat. In order to avoid freezing, the pump is on if the water temperature in the boiler is below Th18 thermostat. If the temperature of water in the boiler exceeds the value Th21 thermostat for safety reasons the pump is always on.

*Sanitary plant*

If the temperature in the sanitary water heater is lower than Th79 and if the temperature in the boiler is higher than Th20 and the difference of temperature of water in the boiler and the sanitary water is Th57, P2 valve is open. If the temperature of water in the boiler has reached the value Th21, P2 valve turns off.

Recommended values of parameters: Th18=5°C, Th19=65°C, Th20=50°C, Th21=70°C; Th57=5°C; Th79=55°C.

Probe S1	Probe S3	Modality	Diff.	P2 Valve	Pump P1
T<5°C				Heat. (OFF)	ON
5°C≤T<50°C				Heat. (OFF)	OFF
50°C≤T<65°C	T<55°C		<5°C	Heat. (OFF)	OFF
			≥5°C	DHW (ON)	ON
	T>55°C		<5°C	Heat. (OFF)	OFF
		Winter	≥5°C	Heat. (OFF)	OFF
	Summer	≥5°C	DHW (ON)	ON	
65°C≤T<70°C	T<55°C		<5°C	Heat. (OFF)	OFF
			≥5°C	DHW (ON)	ON
	T>55°C	Winter		Heat. (OFF)	ON
		Summer	<5°C	DHW (ON)	OFF
	Summer	≥5°C	DHW (ON)	ON	
T≥70°C				Heat. (OFF)	ON

Wiring:

Connect the output for DHW Temperature sensor to the connector as shown in the diagram.

Connect the output for Buffer temperature sensor to the connector.

Connect Pump P3 to the connector as shown in the diagram.

Connect the Electro valve to the connector as shown in the diagram.

Parameters:

*They are factory-set.*

The following parameters are found in the System menu, submenu Enables:

P26 [selection of configuration] =10;

P75 [DHW Temperature sensor] =8;

P76 [Buffer temperature sensor] =9;

P36 [pump configuration] =14

Parameters  $Th18$ ,  $Th19$ ,  $Th20$ ,  $Th21$ ,  $Th57$ ,  $Th79$  are found in the system menu → Thermostats menu and should be adjusted to the needs of the user and the instruction above.

### 7.6.5 Configuration 10.3

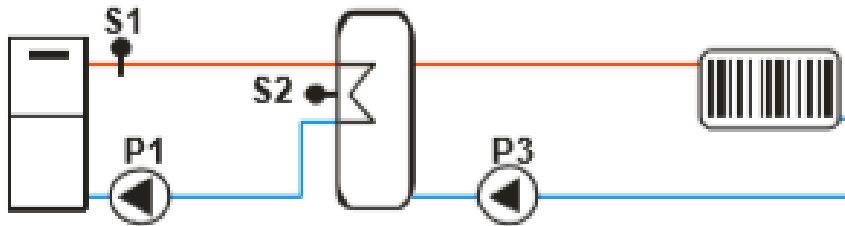

Picture 23. Configuration 10.1

Work principle:

If the temperature in the boiler is higher than  $Th19$  and if the difference between temperatures of two probes is higher than  $Th57$ , the system heats the water in the buffer. P3 Pump is on if the temperature in the buffer has reached  $Th59$ .

Anti-freeze and over temperature protection has been described above.

Example and recommended values:  $Th18=5^{\circ}\text{C}$ ,  $Th19=40^{\circ}\text{C}$ ,  $Th21=70^{\circ}\text{C}$ ,  $Th57=5^{\circ}\text{C}$ ,  $Th59=50^{\circ}\text{C}$ .

S1 probe	Differential	P1 pump
$T < 5^{\circ}\text{C}$		
$T < 40^{\circ}\text{C}$		
$T \geq 40^{\circ}\text{C}$	$< 5^{\circ}\text{C}$	OFF
	$\geq 5^{\circ}\text{C}$	ON
$T \geq 70^{\circ}\text{C}$		ON

S2 probe	Modality	P3 pump
$T < 50^{\circ}\text{C}$		OFF
$T \geq 50^{\circ}\text{C}$	Winter	ON
	Summer	OFF

Wiring:

Connect the output for Buffer temperature sensor to the connector as shown in the diagram.

Connect the output for DHW Temperature sensor to the connector.

Connect the Pump P3 to the connector as shown in the diagram.

Connect the Electro valve to the connector as shown in the diagram.

Parameters:

They are factory-set.

The following parameters are found in the System menu, submenu Enables:

Radijator Inženjering d.o.o, 36000 Kraljevo, Živojina Lazića - Solunca br.6, Srbija  
 tel. +381 36 399 140, fax. +381 36 399 150, <http://www.radijator.rs>  
 e-mail: [radijator@radijator.rs](mailto:radijator@radijator.rs)

P26 [selection of configuration] =10;  
 P75 [DHW Temperature sensor] =8;  
 P76 [Buffer temperature sensor] =9;  
 P36 [configuration of pump] =14

Parameters Th18, Th19, Th20, Th21, Th57, Th79 are found in the system menu → Thermostats menu and should be adjusted to the needs of the user and the instruction above.

### 7.6.6 List of temperature parameters/thermostats

Code	Description	Probe	Unit
Th18	Anti-freeze protection	S1	[°C]
Th19	Activation pump thermostat	S1	[°C]
Ih19	Activation Pump Thermostat Hysteresis	S1	[°C]
Th21	Sanitary 2 Thermostat	S1	[°C]
Ih21	Water Boiler Thermostat Hysteresis 2	S1	[°C]
Ih24	Water Boiler Thermostat Hysteresis	S1	[°C]
Th25	Boiler Safety Thermostat	S1	[°C]
Th26	Boiler Thermostat minimum range	S1	[°C]
Th27	Boiler Thermostat maximum range	S1	[°C]
Th51	Minimum temperature which the user may set in the buffer	S2	[°C]
Th52	Maximum temperature which the user may set in the buffer	S2	[°C]
Th57	Difference between the temperature of water in the boiler and water in the buffer	Dif.	[°C]
Ih57	Differential Thermostat Th57 Hysteresis	Dif.	[°C]
Ih58	Buffer Thermostat Hysteresis	S2	[°C]
Th59	Temperature at which Pump P2 is activated	S2	[°C]
Ih59	Thermostat Th59 Hysteresis	S2	[°C]
Th60	Boiler Return Differential 2 Thermostat Hysteresis (valid only for configuration 8)	Ret. Boiler	[°C]
Ih60	Boiler Return Thermostat Hysteresis	Ret. Boiler	[°C]

Th78	Maximum (safety) temperature of buffer water	Buffer	[°C]
Th80	Maximum (safety) temperature in the sanitary water heater	Sanitary water	[°C]
Th81	Difference between the temperatures of buffer and sanitary water heater.	Diff. 2	[°C]
Ih81	Hysteresis Th81	Diff. 2	[°C]
Th83	Maximum temperature that the user may set in the sanitary water heater	Sanitary water	[°C]
Th97	Difference between the water in the boiler and sanitary water	Diff. 3	[°C]
Ih97	Thermostat Th97 Hysteresis	Diff. 3	[°C]

### 7.7. Protection from blockade of the pump and the three-way valve

If the boiler pump is not working for 24h, the automation system turns on the pump and the three-way valve for 2 minutes in order to avoid the blockade.

### 7.8. Resetting to factory settings

The system may be returned to factory-set parameters.  
 System menu → Restore Parameter's factory value menu.

### 7.9. Boiler commissioning

1. Connect the boiler to the hydraulic scheme;  
 In case of appearance of Er56, see the section 7.1.
2. Connect the boiler to power supply; It is mandatory to turn on the switch on the back of the casing;
3. Using the function manual load let the feeder work for 15-20s;  
 Press the button Set → load → yes → wait for 15-20s → turn off on NO;
4. Start the boiler by pressing and holding the button ON/OFF for 3 seconds.

### 7.10. Maintenance of the *Ecoflame Plus* boiler

Boiler *Ecoflame Plus* demands daily and periodical cleaning.

- Daily cleaning refers to the area of the combustion chamber and cup where, by regularly throwing out the ashes, we enable better work of the electric heating element for ignition and better combustion, i.e. higher amount of air that passes through the slots on the cup. By average parameters of burning 100kg of pellets, 1kg of ashes is produced. The cleaning is performed by a vacuum cleaner for cleaning ashes, when the boiler is completely cold. Picture 22 shows dismantling of the cup when cleaning.

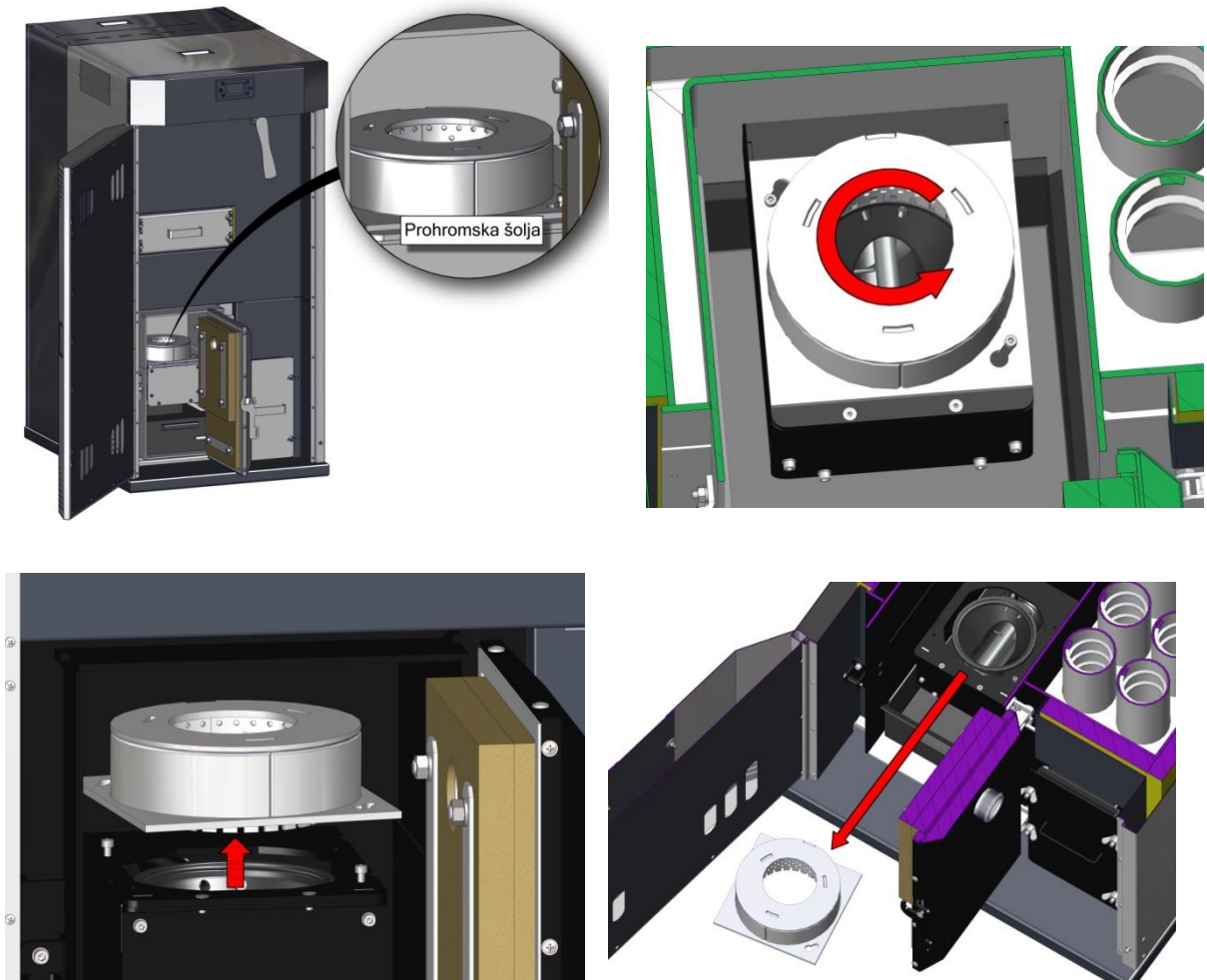

*Picture 24. Dismantling chrome-plated cup when cleaning*

- Daily cleaning also refers to emptying the ashtray (**picture 25**).

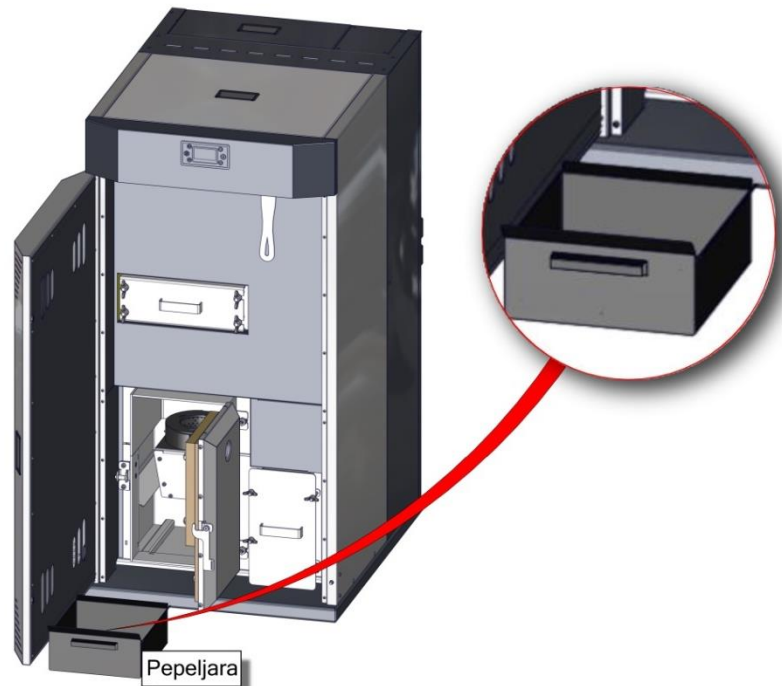

*Picture 25. View of boiler with the ashtray out*

- Periodical cleaning of the boiler includes cleaning of the flue pipes inside the boiler. In order to achieve that, so-called revision openings for cleaning are found in the boiler (pictured 26 and 27). Open the top cover for cleaning, clean the space around the mechanism for cleaning the exchanger pipes; during regular service once a year, tabulates must be taken out and the tar and soot from the available parts of the boiler must be removed.
  - Then take off the cover from the revision opening in the right corner on the front bottom side and clean the space under the exchanger pipes.
  - Revision opening above the combustion chamber should also be cleaned in this period; take off the cover and, by using the vacuum cleaner, pick up tar and soot;In this period, the side door of the casing should be opened and the flue outlet on the back side of the boiler must be cleaned from ashes and tar. (NOTE: Pay attention to the flue gases probe when cleaning the flue outlet).



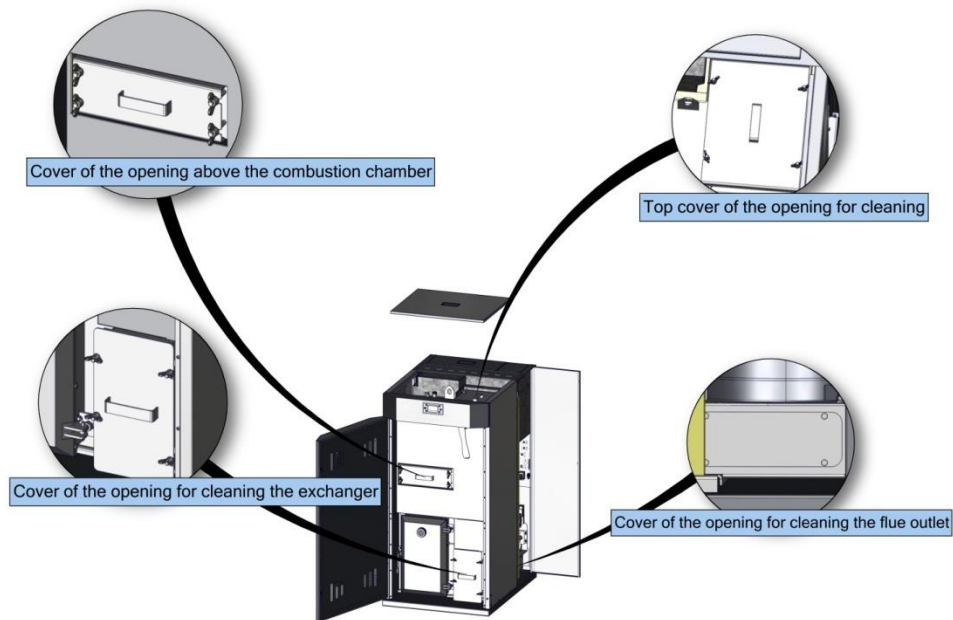

*Picture 26. Covers of revision openings for cleaning the boiler*

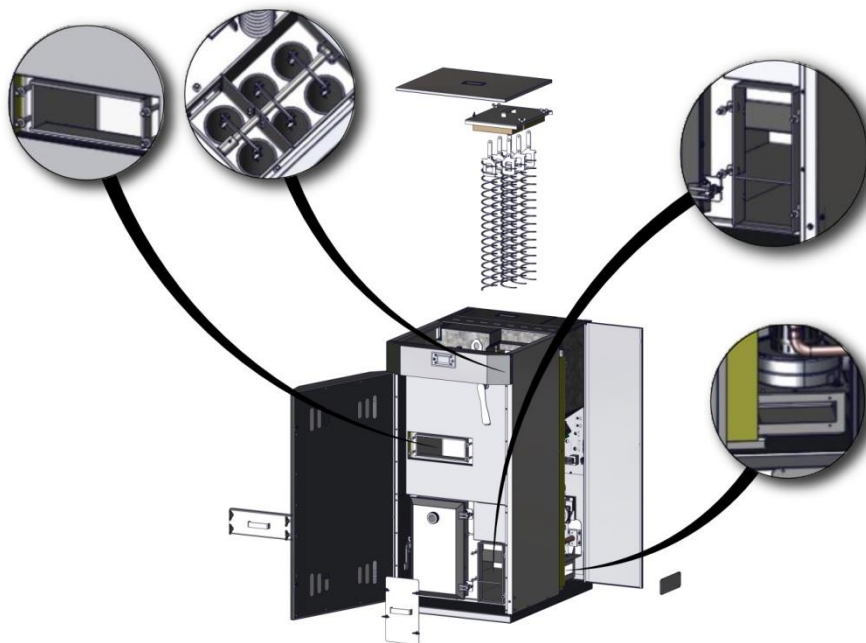



*Picture 27. View of the revision openings for cleaning*

Radijator Inženjering d.o.o, 36000 Kraljevo, Živojina Lazića - Solunca br.6, Srbija  
tel. +381 36 399 140, fax. +381 36 399 150, <http://www.radijator.rs>  
e-mail: [radijator@radijator.rs](mailto:radijator@radijator.rs)

 *During maintenance and servicing of the boiler, disconnect the boiler from the power supply.*

If condensation appears in the boiler during usage, it is necessary to collect the condensed matter and the entire inside of the boiler should be coated with basic means for cleaning or, at least, with aqueous solution of construction lime. In this way the neutralization of acids is carried out due to condensation.

 *In this way, make sure to preserve the boiler at the end of the heating season. In that situation, also close all the openings on the boiler to prevent air circulation through the boiler to avoid potential appearance of moisture in the boiler.*

 *Maintenance of the boiler is one of the most important factors affecting the boiler life expectancy. It is particularly important to clean the boiler when it is not the heating season and neutralize the acid, as described above.*

## 8. Name plate

Name plate is stuck on a visible place on the boiler and contains the following data (see the picture in the item STICKERS)

1. Technical data on the sticker:

- Manufacturer (Radijator Inženjering)
- Serial number of the boiler (example: N°:100113033)
- Year of production (example: 2019)
- Type of the boiler (Ecoflame Plus 25 or Ecoflame Plus 30)
- Nominal power of boiler
- Heat output range
- Necessary chimney draft (18Pa)
- Electric voltage (230V)
- Frequency (50Hz)
- Current (3A)
- Nominal electrical power (490W)
- Maximum extended electrical power (200W)
- All el. power (690W)
- Weight
- Boiler class as per EN3035 (5)
- Maximum pressure (3 bar)
- Maximum temperature (90°C)
- Quantity of water in litres

- Type of fuel sign – pellets C1

2. Sticker of importer 
3. OEEQ
4. Other signs on the boiler

## 10. Sticker

On the *Ecoflame Plus* boiler there are stickers indicating connections and stickers for danger of electric shock, stickers for connection scheme, etc.

### Stickers indicating connections for installation:

7. Sticker (Hot water) 32mm x 74mm



8. Sticker (Cold water) 32mm x 74mm

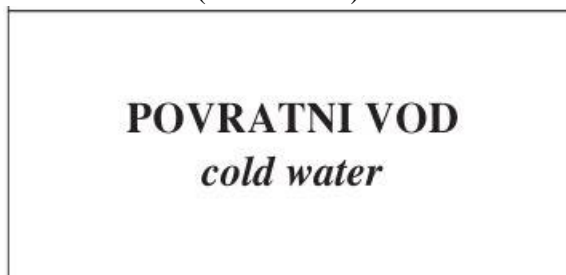

9. Sticker (Safety group) 32mm x 74mm



10. Sticker (Cold water inlet/outlet) 32mm x 74mm

**PUNJENJE/PRAŽNJENJE**  
*cold water inlet/outlet*

11. Sticker (Inlet/outlet of thermal safety relief valve) 32mm x 74mm

**IZMENJIVAČ TERMIČKOG OSIGURANJA**  
*inlet/outlet of thermal safety relief valve*

12. Sticker (Probe of temperature safety relief valve) 32mm x 74mm

**SONDA VENTILA TERMIČKOG OSIGURANJA**  
*probe of temperature safety relief valve*

8. Sticker (Connection scheme) 152mm x 210mm

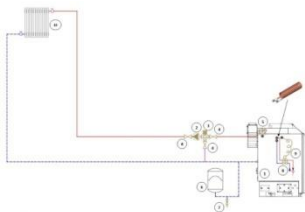

*Identifikacija izuma*

- Opis:**
- |                            |  |
|----------------------------|--|
| 1. Toplinsko letivo 800mm; | 6. Ekspanziona posuda;                 |
| 2. Pumpe;                  | 7. Ventil za punjenje/praznjenje;      |
| 3. Metalni ventili;        | 8. Ventil termičkog osiguranja;        |
| 4. Ventili;                | 9. Sonda ventila termičkog osiguranja; |
| 5. Sigurnosna grupa;       | 10. Izumitelj;                         |

**Stickers that indicate the presence of electricity, high voltage and danger:**

6. Sticker (Hazardous voltage) 60mm x 80mm



7. Sticker (Input with low voltage 12V) 60mm x 80mm



8. Sticker (Hazardous voltage – LARGER) 100mm x 150mm



9. Sticker (Safety electrical connection) 20mm x 30mm



10. Sticker (Presence of voltage)



**Stickers indicating warning:**

4. Sticker (Exposed moving parts can cause severe injury) 30mm x 80mm



5. Sticker (Mandatory commissioning of the boiler by an authorized service technician) 65mm x 247mm



6. Sticker (Attention)



5. Sticker (Waste)





## 11. Manufacturer



RADIJATOR D.O.O.  
Živojina Lazića Solunca br.6  
36000 Kraljevo, Srbija

## 12. Warranty

### 1. Radijator Inženjering covers different warranty periods for different parts (as specified further on) only if the following warranty conditions are fulfilled:

- 1.1. Boiler must be connected as per the stated hydraulic schemes from the instruction manual, especially pay attention to safety valves, thermal safety valve, range of working pressure of boiler, range of working temperature of boiler, conditions in the boiler room, etc. (see item 6)
- 1.2. Boiler must be connected to the chimney of prescribed cross-section, characteristics of insulation and height.
- 1.3. Flue gas outlet from boiler to the chimney must be constructed according to the instruction manual.
- 1.4. Stated electrical connections on the boiler must be done as per the technical instructions, this particularly referring to characteristics of the room thermostat, characteristics of power supply which must be within certain limits.
- 1.5. The user must adhere to the stated instructions on use and maintenance.

### 2. Warranty statement

We, hereby, declare:

- 1.1 That the product has the prescribed and declared quality properties. We undertake, at the request of the buyer, if the request for repair is submitted in due time within the warranty period, to perform, at our expense, all repairs of failures so that the product may work in accordance with the declared properties.
- 1.2 That the product will work impeccably during the warranty period, if the instructions for use, operation and assembly are observed;
- 1.3 That in the warranty period, we will be ready to remove all product failures and keep in stock all the necessary spare parts;
- 1.4 **Warranty period starts from the DATE OF PURCHASE AND LASTS FOR 60 or 72 MONTHS, from the date of production (the date of production is located on the sticker on the back of the boiler);**

**1.5 60 MONTH WARRANTY IS VALID ONLY IF THE BOILER IS SERVICED REGULARLY BY THE CENTRAL SERVICE OF “RADIJATOR INŽINJERING”, within the period specified for the it (in the text below)**

**1.6 The warranty is valid if the warranty card has been verified by the Seller, if the date of purchase has been entered and the attached bill presented. IT IS ALSO IMPORTANT TO HAVE THE ORDER FOR COMMISSIONING (certified by the Authorised Service).**

**3. Warranty period of 2 years applies to the following parts:**

- For all shells;
- Electric heating elements for ignition;

**4. Warranty period of 2 years applies to the following parts:**

- Chains for torque transmission 0.83;
- Lower and upper spiral in feeding system;
- Flue outlet fan;
- Boiler automation system with safety thermostat;
- Flue gases probe;
- Electronic water pump with connectors;
- Boiler water temperature probe;
- Motor gearbox;
- Burner channel T-piece grey cast iron and shell T-piece;
- Electro connectors
- Insulation materials on the door and cleaning openings;
- Safety valve and air vent;
- Chrome plated cup.

**5. Warranty period does not apply:**

- If a regular service is not performed after each heating season;
- For replacement of parts within regular annual maintenance in accordance with the instructions;
- In case of defects caused by the customer due to improper handling of the product;
- For mechanical defects made during transport and during use (solid objects);
- If the product has been installed improperly, contrary to the applicable regulations in this area;
- If it has been established that the hydraulic scheme has not been made according to the recommendations of the company Radijator Inženjering;
- If the customer was using the product over the declared properties under normal circumstances.

**6. The warranty period shall cease to be valid:**

- If it has been established that the failures have been repaired by an unauthorized person or an unauthorized service;
- If the original parts were not used in the repair;
- When the warranty period expires;

**7. When reporting failure, it is obligatory to provide the following information:**

- Name and type of product;
- Date of purchase;

Radijator Inženjering d.o.o, 36000 Kraljevo, Živojina Lazića - Solunca br.6, Srbija  
tel. +381 36 399 140, fax. +381 36 399 150, <http://www.radijator.rs>  
e-mail: [radijator@radijator.rs](mailto:radijator@radijator.rs)

- Factory or workshop number of the boiler;
- A brief description of the failure, or shortcomings;
- The correct address and contact telephone, email;

### **8. Regular annual service:**

Regular service is performed at the end of each heating season in the period from 15<sup>th</sup> April to 31<sup>st</sup> August and is charged according to the set Price list of the company Radijator Inženjering. The service procedure by technicians who perform regular annual services, who are authorized by the manufacturer for doing it, include the following operations

**NOTE: The service technician is obliged to inspect all of the following parts (from the list) of the feeder and exchanger and, if it comes to replacement of any parts, the user shall be granted the above-mentioned warranty, as well as warranty for another 12 months for the body of the boiler (exchanger ). The warranty can be extended for up to 5 years from the date of commissioning. Service and extension of service can be performed by a person sent by the Central Service of Radijator Inženjering. The warranty does not apply for the parts that have not been replaced after the performed service.**

- Dismantling of pellet silo from pellet transporter;
- Dismantling pellet transporter from the boiler;
- Removing both chains;
- Dismantling burner from the combustion chamber and cleaning the combustion chamber under the burner. Checking up the condition of the burner and clearance;
- Cleaning the burner;
- Cleaning the space of pipes of combustion chamber in which the lower spiral rotates;
- Checking the work of the feeding system;
- Take out flue gases probe and clean it;
- Check the work of the fan;
- Check whether the upper and lower door seals properly;
- Check the maintenance of boiler exchanger.